



# RATIO

01.01.2021



# RATIO

You will find exceptional versatility with this functional and flexible shelving system.

This shelving system encapsulates the true meaning of flexibility. Its modular construction provides the highest degree of functionality and versatility and its style; and quality makes it suitable for both contemporary and classic library environments.

The Ratio shelving system offers two different visual and functional options: Ratio-B is without top shelf and the bottom shelf is placed 230 mm above the floor, creating an open, airy feel. The Ratio-S model is with top shelf, bottom shelf as well as a plinth, the bottom shelf being placed only 100 mm from the floor, taking full advantage of the height of the shelving system and is ideal for large volumes often used in scientific libraries. The article number for the bay is the same, the model depends on where you place the shelves on the actual bay.

The design of the shelving system, with 32 mm increments, allows for easy assembly and adjustment without the use of specific tools.

The Ratio Shelving System is available as single- or double-sided and can be fitted with steel or wooden shelves, as well as a wide variety of other functional components. The result – a customisable shelving systems that fits the requirements of your specific library.



**DESIGN OPTIONS**..... 5

**TECHNICAL SPECIFICATIONS**..... 9

## **RATIO SQUARE CONFIGURATIONS**..... 12

Without shelves ..... 14

With shelves ..... 15

## **RATIO SHELVING CONFIGURATIONS** ..... 16

### **WITH CROSS BRACE**

Single-sided ..... 20

Double-sided ..... 21

Single- & double-sided with high intermediate panel..... 22

Double-sided with standard end panels and castors..... 23

Double-sided with standard & functional end panels..... 24

Double-sided with standard & functional end panels & castors..... 25

### **WITH BACK FRAME**

Single-sided ..... 26

Double-sided ..... 28

Single- & double-sided with high intermediate panel..... 30

Double-sided with standard end panels and castors..... 31

Double-sided with standard & functional end panels..... 32

Double-sided with standard & functional end panels & castors..... 35

### **WITH BACK PANEL**

Single-sided ..... 36

Double-sided ..... 38

Single- & double-sided with high intermediate panel..... 40

Double-sided with standard end panels and castors..... 41

Double-sided with standard & functional end panels..... 42

Double-sided with standard & functional end panels & castors..... 45

## **SHELVES**

### **STEEL SHELVES**

Steel shelves ..... 47

Steel pullout shelves..... 49

### **WOODEN SHELVES**

Wooden shelves ..... 50

Wooden cover top shelves ..... 52

## **FUNCTIONS**

### **BOOK SUPPORTS**

Hanging book supports ..... 55

Angled book supports..... 56

### **DISPLAY & STORAGE**

Display & storage - for shelves ..... 58

Display & storage - for crossbar ..... 63

Display & storage - for functional end panels..... 64

### **BROWSERS**

Browsers ..... 66

### **SIGNAGE**

Signage - shelf labelling..... 72

Signage - steel signs..... 75

### **DOORS**

Glass & wooden doors ..... 76



# DESIGN OPTIONS

## **STEEL COMPONENTS** (see overview page 6)

Price Group 1: no surcharge.

Price Group 2: surcharge of 7%.

Price Group 3: other RAL/NCS colours with a starter fee of EUR 250 and with a surcharge of 15%. A higher surcharge for colours with "metallic" look or different surface textures must be expected.

See specific colour for steel gloss specification. Special requests outside specified gloss range are not covered by the above surcharges.

Chrome, electro galvanised and aluminium parts are not available in other colours.

Products such as e.g. wheels and accurides cannot be produced in other colours than described in the price list.

## **WOODEN COMPONENTS** (see overview page 7)

### **MELAMINE COATED**

Price Group A: no surcharge.

Price Group B: surcharge of 10%\*

\*If you wish to order shelf length of W1000 mm in group B, please contact Sales, as prices vary depending on quantity ordered.

### **VENEER**

Price Group C: surcharge of 20%.

### **OTHER FINISHES**

Most of the wooden components are available in other finishes, such as laminate (HPL), with a surcharge, please ask customer service.

# DESIGN OPTIONS

## STANDARD COLOURS AND FINISHES FOR STEEL COMPONENTS

### PRICE GROUP 1 - SMOOTH FINISH (no surcharge)



**A03**  
**Traffic white**  
RAL 9016  
Gloss 75-90



**A02**  
**Oyster white**  
RAL 1013  
Gloss 40-50

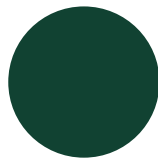

**A22**  
**Moss green**  
RAL 6005  
Gloss 71-85

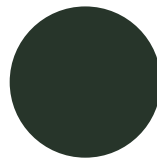

**A26**  
**Fir green**  
RAL 6009  
Gloss 71-85

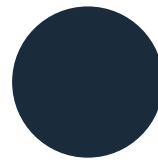

**A12**  
**Steel blue**  
RAL 5011  
Gloss 71-85

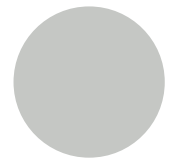

**A13**  
**Light grey**  
RAL 7035  
Gloss 71-85

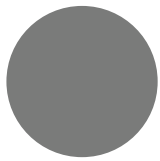

**A15**  
**Dusty grey**  
RAL 7037  
Gloss 71-85

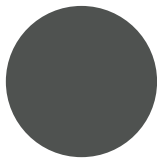

**A16**  
**Traffic grey**  
RAL 7043  
Gloss 71-85

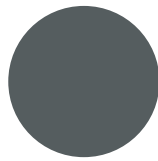

**A17**  
**Basalt grey**  
RAL 7012  
Gloss 71-85

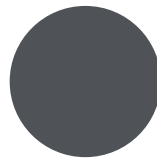

**A18**  
**Slate grey**  
RAL 7015  
Gloss 71-85

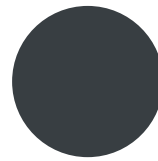

**A19**  
**Anthracite grey**  
RAL 7016  
Gloss 71-85



**A25**  
**Jet black**  
RAL 9005  
Gloss 71-85

### PRICE GROUP 2 - SMOOTH FINISH (7% surcharge)



**A01**  
**Pure white**  
RAL 9010  
Gloss 71-85

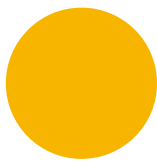

**A04**  
**Traffic yellow**  
RAL 1023  
Gloss 71-85

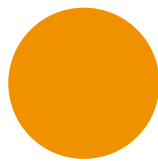

**A05**  
**Sun yellow**  
RAL 1037  
Gloss 71-85

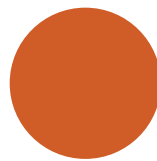

**A06**  
**Signal orange**  
RAL 2010  
Gloss 71-85

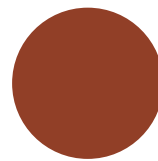

**A07**  
**Pearl orange**  
RAL 2013  
Gloss 65-85

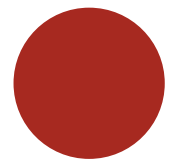

**A08**  
**Flame red**  
RAL 3000  
Gloss 71-85

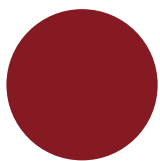

**A09**  
**Ruby red**  
RAL 3003  
Gloss 71-85



**A21**  
**Reseda green**  
RAL 6011  
Gloss 71-85

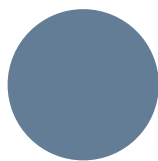

**A10**  
**Pigeon blue**  
RAL 5014  
Gloss 71-85

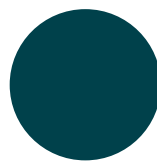

**A11**  
**Ocean blue**  
RAL 5020  
Gloss 71-85

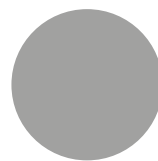

**A14**  
**White aluminium**  
RAL 9006  
Gloss 50-70

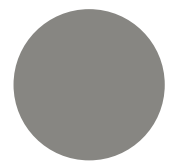

**A31**  
**Grey aluminium**  
RAL 9007  
Gloss 50-70

### PRICE GROUP 2 - TEXTURED FINISH (7% surcharge)



**A27**  
**Pure white**  
RAL 9010

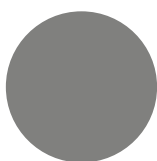

**A29**  
**Concertina grey**

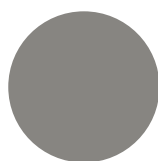

**A28**  
**Grey aluminium**  
RAL 9007

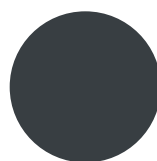

**A23**  
**Anthracite grey**  
RAL 7016

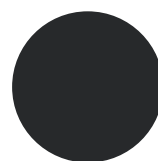

**A24**  
**Graphite black**  
RAL 9011

# DESIGN OPTIONS

## STANDARD COLOURS AND FINISHES FOR WOODEN COMPONENTS

### PRICE GROUP A - MELAMINE (no surcharge)

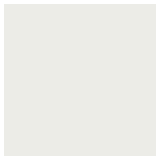

**D61**  
**Signal white**  
RAL 9003



**D72**  
**Oyster white**  
Similar to RAL 1013

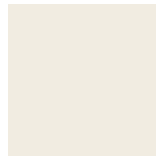

**D62**  
**Pure white**  
Similar to RAL 9010



**D63**  
**Steel blue**  
RAL 5011



**D71**  
**Dusty grey**  
Similar to RAL 7037



**D16**  
**Basalt grey**  
Similar to RAL 7012



**D19**  
**Slate grey**  
Similar to RAL 7015 and  
RAL 7016



**D04**  
**Beech decor**



**D05**  
**Maple decor**



**D06**  
**Cherry decor**



**D07**  
**Oak decor**



**D08**  
**Olive decor**



**D64**  
**Signal yellow**  
RAL 1003



**D65**  
**Yellow orange**  
RAL 2000



**D66**  
**Pure orange**  
RAL 2004



**D67**  
**Traffic red**  
RAL 3020



**E02**  
**Ruby red**  
Similar to RAL 3003



**D13**  
**Lime green**  
Similar to NCS S1060-G40Y



**D68**  
**Reseda green**  
Similar to RAL 6011



**D73**  
**Pigeon blue**  
RAL 5014



**D74**  
**Ocean blue**  
Similar to RAL 5020

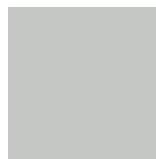

**D69**  
**Light grey**  
Similar to RAL 7035



**D70**  
**White aluminium**  
Similar to RAL 9006



**D75**  
**Jet black**  
Similar to RAL 9005

### PRICE GROUP C - VENEER (20% surcharge)



**F01**  
**Beech**



**F02**  
**Maple**



**F03**  
**Oak**



**Houthalen Public Library, Belgium**  
Ratio shelving with functional end panels



# TECHNICAL SPECIFICATIONS

## GENERAL SPECIFICATIONS

### DIMENSIONS

Dimensions of each component can be found under the individual products. All cited measurements are nominal sizes. The actual size of a module measuring 1000 mm is 995 mm etc.

### MAXIMUM LOAD

Wooden and steel shelves are to be loaded with a maximum of 80 kg.

### BAY CONSTRUCTION - STARTER AND ADD-ON BAY - SAME HEIGHT

A starter bay includes one right and one left end panel with holes on the inside of the panel. To add another bay, you must take off the right end panel, insert the add-on bay (with one intermediate panel with holes on both sides) and fix the right end panel to the add-on bay. See example below.

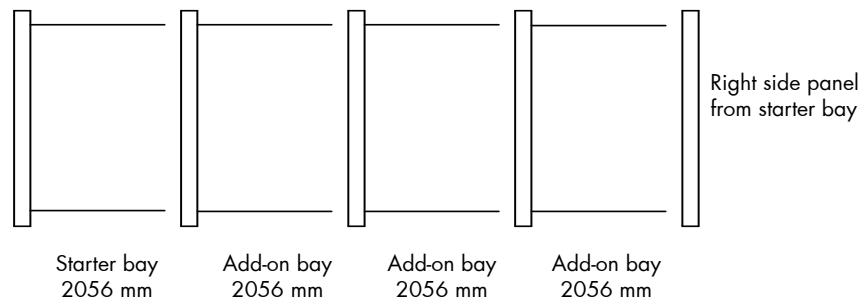

### BAY CONSTRUCTION - STARTER AND ADD-ON BAY - VARIOUS HEIGHTS

When constructing a shelving system with various heights, you must take care when ordering starter and add-on bays. See example below.

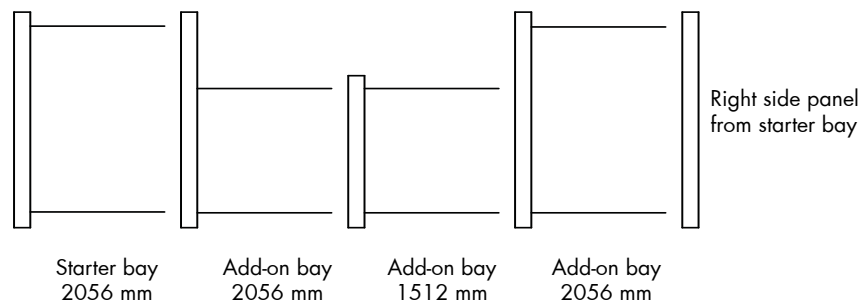

### BAYS WITH CASTORS

Only double-sided shelving with back frame support with a max. height of 1768 mm can be mounted on castors, and only double-sided shelving with cross brace/back panel with a max. height of 2056 mm can be mounted on castors. Castors are only to be mounted on a max. of 2 adjoining bays. Castors are available as soft/hard and with/without brakes. Max. load of 90 kg per castor.

### SHELVES WITH SCREWS AND PINS

Wooden and steel shelves are delivered with either screws (for fixation) or pins (for insertion). Each bay must have at least 2 shelves (4 shelves for double-sided bays) - top and bottom - screwed into the panels for stability. The remaining shelves can be inserted via pins. See overview below for amount of shelves necessary for each bay height

H1096 mm - 2 shelves - top and bottom

H1512 mm and higher - 3 shelves - top, intermediate and bottom

### ASSEMBLY

All wooden shelving units come knocked-down. No special fittings or tools are needed.

# TECHNICAL SPECIFICATIONS

## STEEL COMPONENTS

### **STEEL COMPONENTS**

are powder coated with standard polyester based powders that secures high UV resistance. Powders comply with EN 45545 (fire protection - similar to DIN 4201). Thickness of the coating is 60-80 my.

The powder used includes:

- no triglycidylisocyanurate (TGIC)
- no heavy metal-containing pigments such as lead and cadmium
- no volatiles

Antibacterial equipping of surfaces upon request.

### **CROSS BRACES**

are made of galvanized steel Ø4 mm. When installed the cross brace has a total height of 1340 mm, the cross brace can therefore not be used for bays H1096 mm.

### **BACK FRAMES**

are made of 30 x 15 x 2 mm rectangular steel tubes.

### **SHELVES**

are made of 1 mm steel.

### **FRAMES FOR CASTORS**

are made of 40 x 20 x 2 mm rectangular steel tubes and 40 x 5 mm flat steel.

# TECHNICAL SPECIFICATIONS

## WOODEN AND GLASS COMPONENTS

### WOODEN COMPONENTS

are either melamine coated or have an environmental-friendly transparent lacquered veneer finish. Differences in colour underline the characteristics of veneer and cannot be avoided.

#### MELAMINE COATED AND VENEER END PANELS

are made of 25 mm E1 quality particle board. End panels are also available in 26 mm glued solid beech or oak upon request.

#### MELAMINE COATED AND VENEER INTERMEDIATE PANELS

are made of 25 mm E1 quality particle board.

#### MELAMINE COATED AND VENEER FUNCTIONAL END PANELS

are made of 25 mm E1 quality particle board.

#### MELAMINE COATED AND VENEER BACK PANELS

are made of 16 mm E1 quality particle board.

#### MELAMINE COATED AND VENEER SHELVES

500, 750 and 900 mm shelves are made of 25 mm E1 quality particle board.  
1000 mm shelves are made of 25 mm blockboard (to prevent shelf from sagging).

#### MELAMINE COATED AND VENEER TOP COVER

are made of 25 mm E1 quality particle board.

#### MELAMINE COATED AND VENEER DOORS

are made of 19 mm E1 quality particle board.

### GLASS COMPONENTS

#### GLASS DOORS

are made of 6 mm toughened glass (ESG).



# RATIO SQUARE

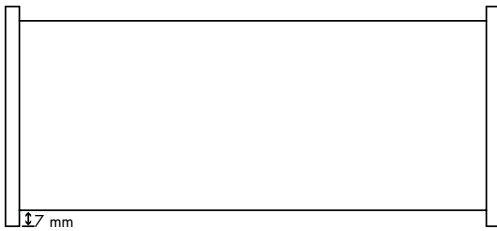

The Ratio panel comes with a flat front end. The shelves are almost flush with the panels, the distance between the front edge of the panel and the front edge of the shelf is 7 mm. The holes are placed 37 mm from the edge of the panel.

Ratio panels are delivered as standard with 25 mm E-1 quality particle board with melamine coated/veneer finish.

## HEIGHTS

Ratio Square is available in 3 heights; 1096/1101, 1512/1517 and 1768/1773 mm (with H95 mm castors /H100 mm plinth). The shelves are adjustable in 32 mm increments.

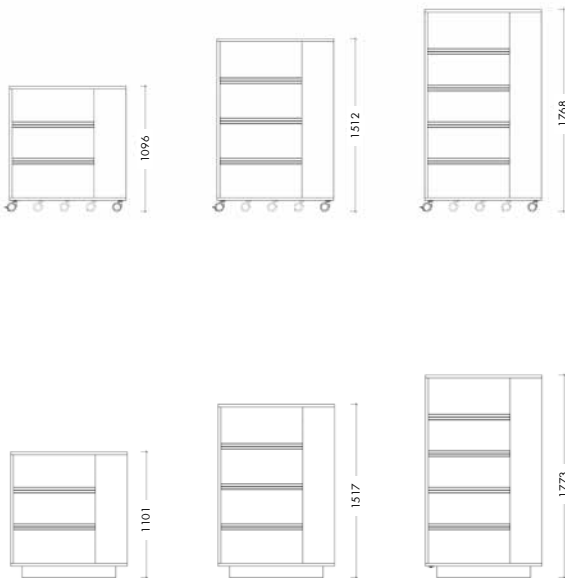

## WIDTHS

The bays are available in 3 widths: 500, 750 and 900 mm. The total width of the unit depends on your choice of both shelf width and shelf depth.

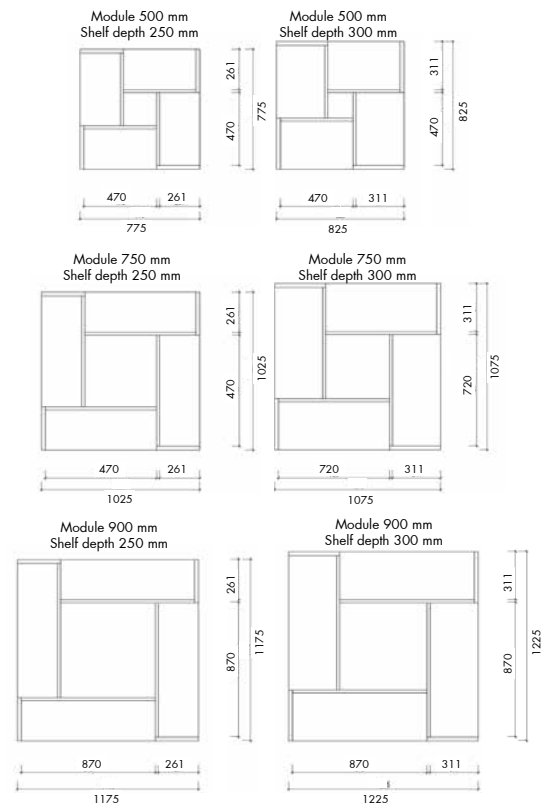

## DEPTHS

The panels are available in 2 depths: 250 and 300 mm. Actual width of single-sided 250 mm panel is 287 mm. Actual width of single-sided 300 mm panel is 337 mm.

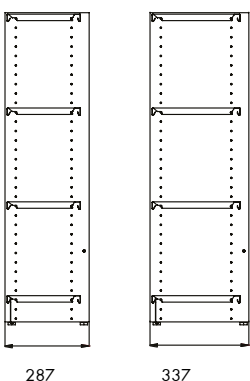

# RATIO SQUARE

## CONFIGURATIONS WITHOUT SHELVES

A complete square shelving with end panels, back panel, top and bottom plate. There are 8 castors in total (4 inner castors without brakes, 4 outer castors with brake). See pages 43-70 for shelves and functions for Ratio Square.

### Height 1096 / 1101 mm (with castors/plinth)

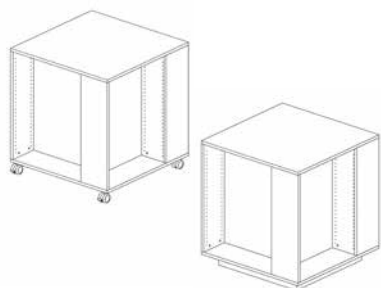

Module mm	Shelf depth mm	Item no. With castors	Item no. With plinth
500	250	SRTB7520GRM	SRTB7525GRM
500	300	SRTB7520GRN	SRTB7525GRN
750	250	SRTB7520GSM	SRTB7525GSM
750	300	SRTB7520GSN	SRTB7525GSN
900	250	SRTB7520GUM	SRTB7525GUM
900	300	SRTB7520GUN	SRTB7525GUN

### Height 1512 / 1517 mm (with castors/plinth)

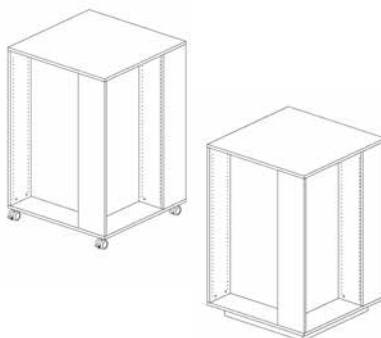

Module mm	Shelf depth mm	Item no. With castors	Item no. With plinth
500	250	SRTB7520CRM	SRTB7525CRM
500	300	SRTB7520CRN	SRTB7525CRN
750	250	SRTB7520CSM	SRTB7525CSM
750	300	SRTB7520CSN	SRTB7525CSN
900	250	SRTB7520CUM	SRTB7525CUM
900	300	SRTB7520CUN	SRTB7525CUN

### Height 1768 / 1773 mm (with castors/plinth)

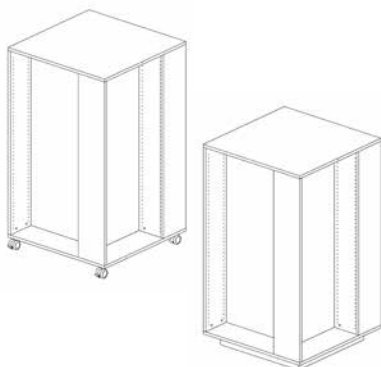

Module mm	Shelf depth mm	Item no. With castors	Item no. With plinth
500	250	SRTB7520ARM	SRTB7525ARM
500	300	SRTB7520ARN	SRTB7525ARN
750	250	SRTB7520ASM	SRTB7525ASM
750	300	SRTB7520ASN	SRTB7525ASN
900	250	SRTB7520AUM	SRTB7525AUM
900	300	SRTB7520AUN	SRTB7525AUN

# RATIO SQUARE

## CONFIGURATIONS WITH SHELVES

A complete square shelving with end panels, back panel, top and bottom plate, shelves, screws and plastic spacer/pins. There are 8 castors in total (4 inner castors without braces, 4 outer castors with brake). The number of shelves is calculated for optimal shelf spacing for fiction.

Height 1096 / 1101 mm (with castors/plinth) - 8 shelves, 2 on each side

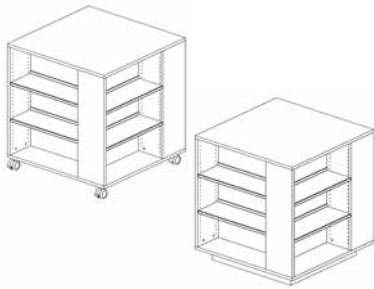

Module mm	Shelf depth mm	Item no. With castors	Item no. With plinth
500	250	SRTB7530GRM	SRTB7535GRM
500	300	SRTB7530GRN	SRTB7535GRN
750	250	SRTB7530GSM	SRTB7535GSM
750	300	SRTB7530GSN	SRTB7535GSN
900	250	SRTB7530GUM	SRTB7535GUM
900	300	SRTB7530GUN	SRTB7535GUN

Height 1512 / 1517 mm (with castors/plinth) - 12 shelves, 3 on each side

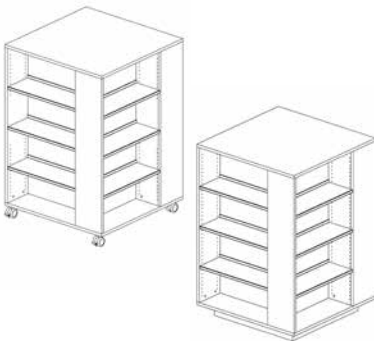

Module mm	Shelf depth mm	Item no. With castors	Item no. With plinth
500	250	SRTB7530CRM	SRTB7535CRM
500	300	SRTB7530CRN	SRTB7535CRN
750	250	SRTB7530CSM	SRTB7535CSM
750	300	SRTB7530CSN	SRTB7535CSN
900	250	SRTB7530CUM	SRTB7535CUM
900	300	SRTB7530CUN	SRTB7535CUN

Height 1768/1773 mm (with castors/plinth) - 16 shelves, 4 on each side



Module mm	Shelf depth mm	Item no. With castors	Item no. With plinth
500	250	SRTB7530ARM	SRTB7535ARM
500	300	SRTB7530ARN	SRTB7535ARN
750	250	SRTB7530ASM	SRTB7535ASM
750	300	SRTB7530ASN	SRTB7535ASN
900	250	SRTB7530AUM	SRTB7535AUM
900	300	SRTB7530AUN	SRTB7535AUN

# RATIO SHELVING

The following pages will show basic configurations of the Ratio shelving system. The article numbers are made according to the following system:

Pos. 1	Pos. 2-3	Pos. 4	Pos. 5-6	Pos. 7	Pos. 8	Pos. 9	Pos. 10	Pos. 11
Company name	Shelving type	Business number	Bay type	Panel type	Connection element	Height mm	Module mm	Shelf depth mm
S	RT	B	11	1	1	G	W	M
Schulz	Ratio	B	11: SS starter 12: SS add-on 13: DS starter 14: DS add-on 16: DS starter with castors 17: DS add-on with castors	1: Melamine coated / veneer	1: Cross brace 2: Back panel 3: Back frame	G: 1096 C: 1512 A: 1768 D: 2056 E: 2248	R: 500 S: 750 U: 900 W: 1000	M: 250 N: 300

The Ratio shelving system offers two different visual and functional options:

## RATIO-B

This system offers the open floor space often required for open-shelf libraries, as the bottom shelf is placed 230 mm above the floor and is without plinth. You still have the option adding a top shelf.

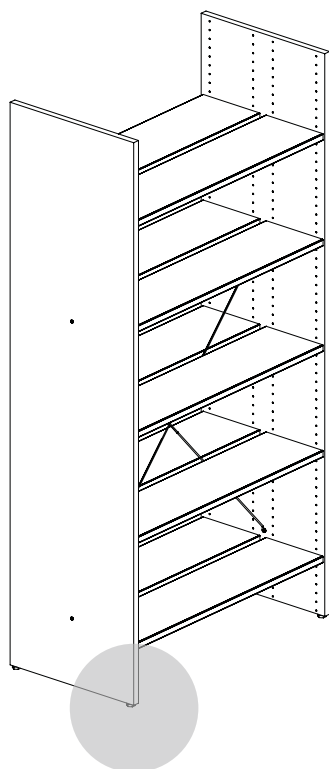

## RATIO-S

This system offers the option of adding both top and bottom shelf, as well as a plinth, making a fully enclosed wooden shelving system. The bottom shelf is placed 100 mm above the floor.

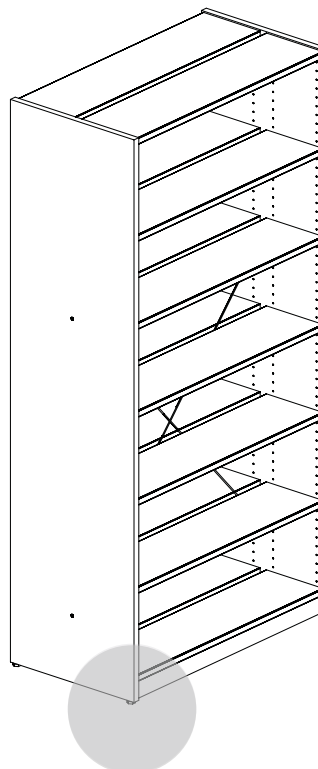



# RATIO SHELVING

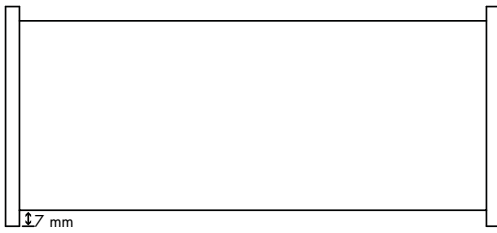

The Ratio panel comes with a flat front end. The shelves are almost flush with the panels, the distance between the front edge of the panel and the front edge of the shelf is 7 mm. The holes are placed 37 mm from the edge of the panel.

Ratio panels are delivered as standard with 25 mm E-1 quality particle board with melamine coated/veneer finish but can also be delivered in solid 26 mm beech or oak upon request.

## HEIGHTS

Ratio shelving system is available in 5 heights; 1096, 1512, 1768, 2056 and 2248 mm. Heights include adjustable feet (max. 15 mm) with leveling screws in steel threads. The shelves are adjustable in 32 mm increments. Depending on where the shelves are inserted, the following variations are possible:

### RATIO-B

### RATIO-S

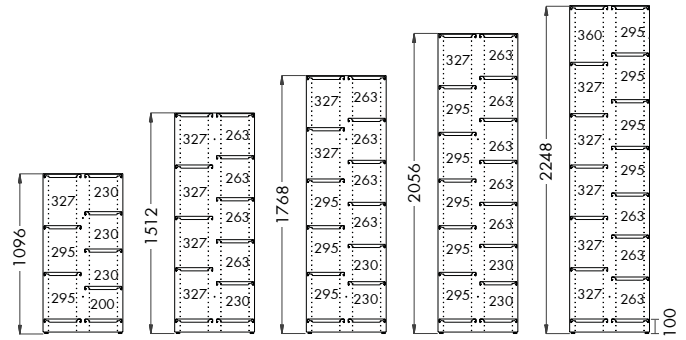
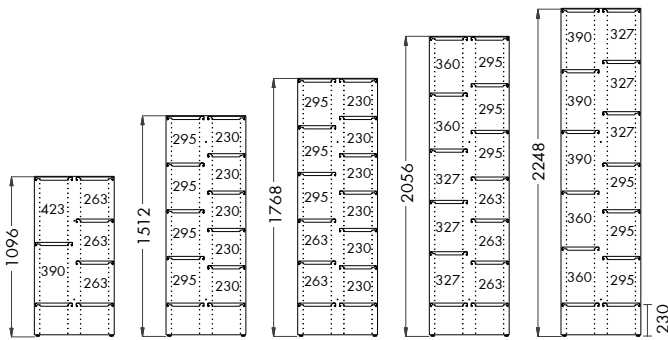

## DEPTHS

The panels are available in 2 depths: 250 and 300 mm.

Actual width of single-sided 250 mm panel is 287 mm  
 Actual width of single-sided 300 mm panel is 337 mm  
 Actual width of double-sided 250 mm panel is 540 mm  
 Actual width of double-sided 300 mm panel is 640 mm

## WIDTHS

The bays are available in 4 widths and as starter and add-on bays. A starter bay has two side panels and an add-on bay has one side panel.

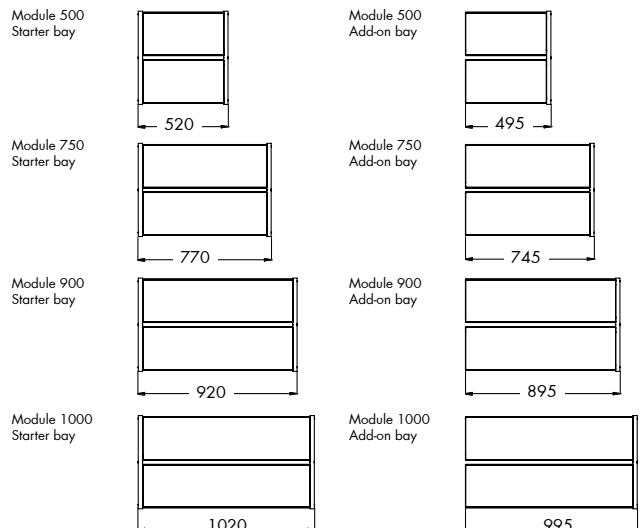
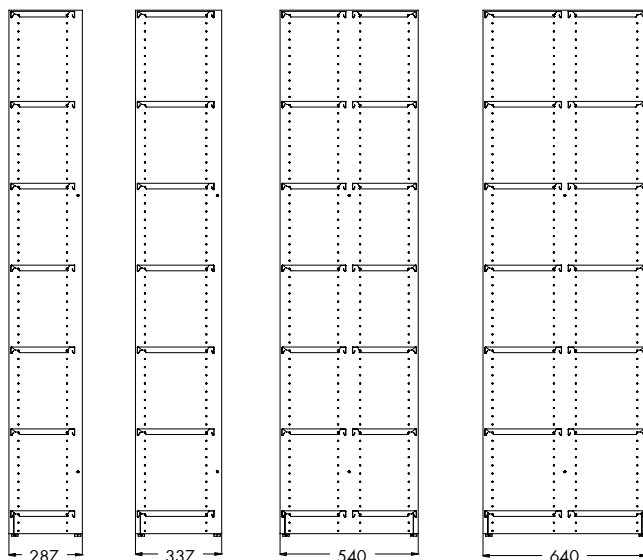

# PANEL OPTIONS

Ratio panels are delivered as standard with 25 mm E-1 quality particle board with melamine coated/veneer finish as either standard end panel or with functional end panel.



# PANEL OPTIONS

You also have the option of having end panels delivered in solid 26 mm beech or oak or add an end panel in perforated steel.



# RATIO SHELVING

## SINGLE-SIDED - CROSS BRACE

The starter bay includes two end panels (with holes on the inside), cross brace and fittings. The add-on bay includes one intermediate panel (with holes on both sides), cross brace and fittings. Bay with cross brace is not available for H1096 mm due to height of cross brace. For shelves and functions, see from page 43.

### Height 1512 mm

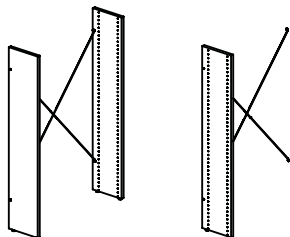

Module mm	Shelf depth mm	Item no. Starter bay	Item no. Add-on bay
500	250	SRTB1111CRM	SRTB1211CRM
500	300	SRTB1111CRN	SRTB1211CRN
750	250	SRTB1111CSM	SRTB1211CSM
750	300	SRTB1111CSN	SRTB1211CSN
900	250	SRTB1111CUM	SRTB1211CUM
900	300	SRTB1111CUN	SRTB1211CUN
1000	250	SRTB1111CWM	SRTB1211CWM
1000	300	SRTB1111CWN	SRTB1211CWN

### Height 1768 mm

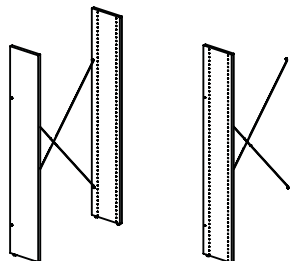

Module mm	Shelf depth mm	Item no. Starter bay	Item no. Add-on bay
500	250	SRTB1111ARM	SRTB1211ARM
500	300	SRTB1111ARN	SRTB1211ARN
750	250	SRTB1111ASM	SRTB1211ASM
750	300	SRTB1111ASN	SRTB1211ASN
900	250	SRTB1111AUM	SRTB1211AUM
900	300	SRTB1111AUN	SRTB1211AUN
1000	250	SRTB1111AWM	SRTB1211AWM
1000	300	SRTB1111AWN	SRTB1211AWN

### Height 2056 mm

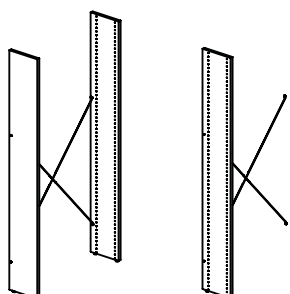

Module mm	Shelf depth mm	Item no. Starter bay	Item no. Add-on bay
500	250	SRTB1111DRM	SRTB1211DRM
500	300	SRTB1111DRN	SRTB1211DRN
750	250	SRTB1111DSM	SRTB1211DSM
750	300	SRTB1111DSN	SRTB1211DSN
900	250	SRTB1111DUM	SRTB1211DUM
900	300	SRTB1111DUN	SRTB1211DUN
1000	250	SRTB1111DWM	SRTB1211DWM
1000	300	SRTB1111DWN	SRTB1211DWN

### Height 2248 mm

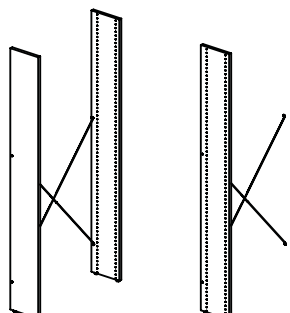

Module mm	Shelf depth mm	Item no. Starter bay	Item no. Add-on bay
500	250	SRTB1111ERM	SRTB1211ERM
500	300	SRTB1111ERN	SRTB1211ERN
750	250	SRTB1111ESM	SRTB1211ESM
750	300	SRTB1111ESN	SRTB1211ESN
900	250	SRTB1111EUM	SRTB1211EUM
900	300	SRTB1111EUN	SRTB1211EUN
1000	250	SRTB1111EWM	SRTB1211EWM
1000	300	SRTB1111EWN	SRTB1211EWN

# RATIO SHELVING

## DOUBLE-SIDED - CROSS BRACE

The starter bay includes two end panels (with holes on the inside), cross brace and fittings. The add-on bay includes one intermediate panel (with holes on both sides), cross brace and fittings. Bay with cross brace is not available for H1096 mm due to height of cross brace. For shelves and functions, see from page 43.

### Height 1512 mm

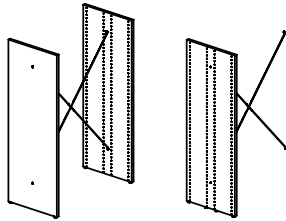

Module mm	Shelf depth mm	Item no. Starter bay	Item no. Add-on bay
500	250	SRTB1311CRM	SRTB1411CRM
500	300	SRTB1311CRN	SRTB1411CRN
750	250	SRTB1311CSM	SRTB1411CSM
750	300	SRTB1311CSN	SRTB1411CSN
900	250	SRTB1311CUM	SRTB1411CUM
900	300	SRTB1311CUN	SRTB1411CUN
1000	250	SRTB1311CWM	SRTB1411CWM
1000	300	SRTB1311CWN	SRTB1411CWN

### Height 1768 mm

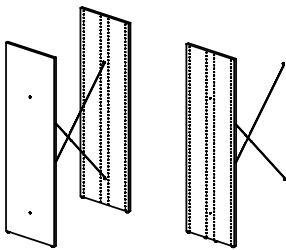

Module mm	Shelf depth mm	Item no. Starter bay	Item no. Add-on bay
500	250	SRTB1311ARM	SRTB1411ARM
500	300	SRTB1311ARN	SRTB1411ARN
750	250	SRTB1311ASM	SRTB1411ASM
750	300	SRTB1311ASN	SRTB1411ASN
900	250	SRTB1311AUM	SRTB1411AUM
900	300	SRTB1311AUN	SRTB1411AUN
1000	250	SRTB1311AWM	SRTB1411AWM
1000	300	SRTB1311AWN	SRTB1411AWN

### Height 2056 mm

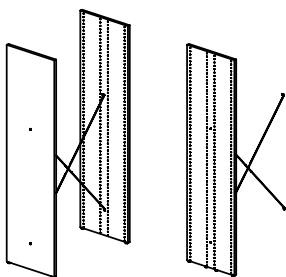

Module mm	Shelf depth mm	Item no. Starter bay	Item no. Add-on bay
500	250	SRTB1311DRM	SRTB1411DRM
500	300	SRTB1311DRN	SRTB1411DRN
750	250	SRTB1311DSM	SRTB1411DSM
750	300	SRTB1311DSN	SRTB1411DSN
900	250	SRTB1311DUM	SRTB1411DUM
900	300	SRTB1311DUN	SRTB1411DUN
1000	250	SRTB1311DWM	SRTB1411DWM
1000	300	SRTB1311DWN	SRTB1411DWN

### Height 2248 mm

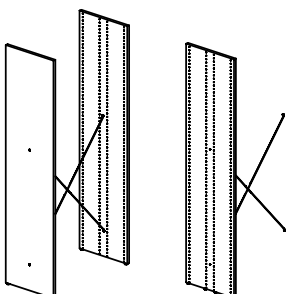

Module mm	Shelf depth mm	Item no. Starter bay	Item no. Add-on bay
500	250	SRTB1311ERM	SRTB1411ERM
500	300	SRTB1311ERN	SRTB1411ERN
750	250	SRTB1311ESM	SRTB1411ESM
750	300	SRTB1311ESN	SRTB1411ESN
900	250	SRTB1311EUM	SRTB1411EUM
900	300	SRTB1311EUN	SRTB1411EUN
1000	250	SRTB1311EWM	SRTB1411EWM
1000	300	SRTB1311EWN	SRTB1411EWN

# RATIO SHELVING

## SINGLE- & DOUBLE-SIDED - CROSS BRACE - HIGH INTERMEDIATE PANEL

To be used in between standard end panels to create different design/look. The add-on bay includes one intermediate panel (with holes on both sides), cross brace and fittings. Bay with cross brace is not available for H1096 mm due to height of cross brace. For shelves and functions, see from page 43.

### Height 1512 mm

H1812 x D337/387 or D640/740 mm. The panel is 300 mm higher than the standard 1512 mm panel and 50/100 mm deeper.

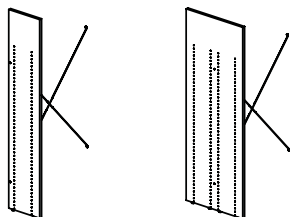

Module mm	Shelf depth mm	Item no. Single-sided	Item no. Double-sided
500	250	SRTB1251CRM	SRTB1451CRM
500	300	SRTB1251CRN	SRTB1451CRN
750	250	SRTB1251CSM	SRTB1451CSM
750	300	SRTB1251CSN	SRTB1451CSN
900	250	SRTB1251CUM	SRTB1451CUM
900	300	SRTB1251CUN	SRTB1451CUN
1000	250	SRTB1251CWM	SRTB1451CWM
1000	300	SRTB1251CWN	SRTB1451CWN

### Height 1768 mm

H2068 x D337/387 or D640/740 mm. The panel is 300 mm higher than the standard 1768 mm panel and 50/100 mm deeper.

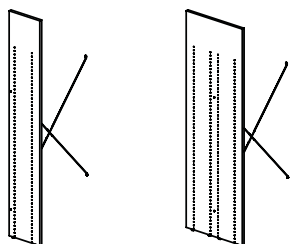

Module mm	Shelf depth mm	Item no. Single-sided	Item no. Double-sided
500	250	SRTB1251ARM	SRTB1451ARM
500	300	SRTB1251ARN	SRTB1451ARN
750	250	SRTB1251ASM	SRTB1451ASM
750	300	SRTB1251ASN	SRTB1451ASN
900	250	SRTB1251AUM	SRTB1451AUM
900	300	SRTB1251AUN	SRTB1451AUN
1000	250	SRTB1251AWM	SRTB1451AWM
1000	300	SRTB1251AWN	SRTB1451AWN

# RATIO SHELVING

## DOUBLE-SIDED - CROSS BRACE - STANDARD END PANELS - CASTORS

The starter bay includes two end panels (with holes on the inside), cross brace, fittings and castors (4 standard, hard castors without brakes). The add-on bay includes one intermediate panel (with holes on both sides), cross brace, fittings and castors (as above). Bay with cross brace is not available for H1096 mm due to height of cross brace. Castors are available as hard/soft and with/without brakes. For shelves and functions, see from page 43.

### Height 1512 mm

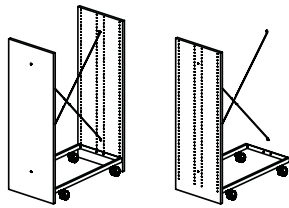

Module mm	Shelf depth mm	Item no. Starter bay	● ■	Item no. Add-on bay	● ■
500	250	SRTB1611CRM		SRTB1711CRM	
500	300	SRTB1611CRN		SRTB1711CRN	
750	250	SRTB1611CSM		SRTB1711CSM	
750	300	SRTB1611CSN		SRTB1711CSN	
900	250	SRTB1611CUM		SRTB1711CUM	
900	300	SRTB1611CUN		SRTB1711CUN	
1000	250	SRTB1611CWM		SRTB1711CWM	
1000	300	SRTB1611CWN		SRTB1711CWN	

### Height 1768 mm

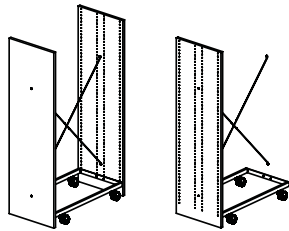

Module mm	Shelf depth mm	Item no. Starter bay	● ■	Item no. Add-on bay	● ■
500	250	SRTB1611ARM		SRTB1711ARM	
500	300	SRTB1611ARN		SRTB1711ARN	
750	250	SRTB1611ASM		SRTB1711ASM	
750	300	SRTB1611ASN		SRTB1711ASN	
900	250	SRTB1611AUM		SRTB1711AUM	
900	300	SRTB1611AUN		SRTB1711AUN	
1000	250	SRTB1611AWM		SRTB1711AWM	
1000	300	SRTB1611AWN		SRTB1711AWN	

### Height 2056 mm

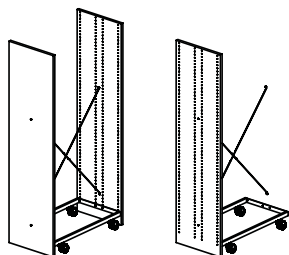

Module mm	Shelf depth mm	Item no. Starter bay	● ■	Item no. Add-on bay	● ■
500	250	SRTB1611DRM		SRTB1711DRM	
500	300	SRTB1611DRN		SRTB1711DRN	
750	250	SRTB1611DSM		SRTB1711DSM	
750	300	SRTB1611DSN		SRTB1711DSN	
900	250	SRTB1611DUM		SRTB1711DUM	
900	300	SRTB1611DUN		SRTB1711DUN	
1000	250	SRTB1611DWM		SRTB1711DWM	
1000	300	SRTB1611DWN		SRTB1711DWN	

# RATIO SHELVING

## DOUBLE-SIDED - CROSS BRACE - STANDARD AND FUNCTIONAL END PANELS

For display. Choose between 1 standard and 1 functional end panel or 2 functional end panels. A complete bay includes two end panels (with holes on the inside), cross brace and fittings. For shelves and functions for the bays, see from page 43. For accessories for the functional end panels, see page 60.

### Height 1512 mm

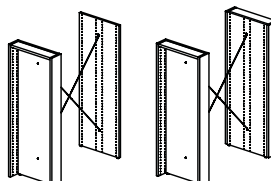

Module mm	Shelf depth mm	Item no. 1 of each end panel	Item no. 2 func. end panels
500	250	SRTB1351CRM	SRTB1341CRM
500	300	SRTB1351CRN	SRTB1341CRN
750	250	SRTB1351CSM	SRTB1341CSM
750	300	SRTB1351CSN	SRTB1341CSN
900	250	SRTB1351CUM	SRTB1341CUM
900	300	SRTB1351CUN	SRTB1341CUN
1000	250	SRTB1351CWM	SRTB1341CWM
1000	300	SRTB1351CWN	SRTB1341CWN

### Height 1768 mm

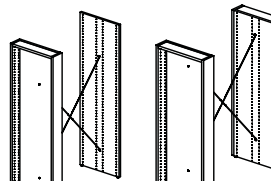

Module mm	Shelf depth mm	Item no. 1 of each end panel	Item no. 2 func. end panels
500	250	SRTB1351ARM	SRTB1341ARM
500	300	SRTB1351ARN	SRTB1341ARN
750	250	SRTB1351ASM	SRTB1341ASM
750	300	SRTB1351ASN	SRTB1341ASN
900	250	SRTB1351AUM	SRTB1341AUM
900	300	SRTB1351AUN	SRTB1341AUN
1000	250	SRTB1351AWM	SRTB1341AWM
1000	300	SRTB1351AWN	SRTB1341AWN



# RATIO SHELVING

## DOUBLE-SIDED - CROSS BRACE - STANDARD AND FUNCTIONAL END PANELS - CASTORS

For display. Choose between 1 standard and 1 functional end panel or 2 functional end panels. A complete bay includes two end panels (with holes on the inside), cross brace, fittings and castors (4 standard, hard castors without brakes). For shelves and functions for the bays, see from page 43. For accessories for the functional end panels, see page 60.

### Height 1512 mm

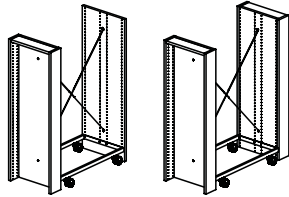

Module mm	Shelf depth mm	Item no. 1 of each end panel	Item no. 2 func. end panels
500	250	SRTB1651CRM	SRTB1641CRM
500	300	SRTB1651CRN	SRTB1641CRN
750	250	SRTB1651CSM	SRTB1641CSM
750	300	SRTB1651CSN	SRTB1641CSN
900	250	SRTB1651CUM	SRTB1641CUM
900	300	SRTB1651CUN	SRTB1641CUN
1000	250	SRTB1651CWM	SRTB1641CWM
1000	300	SRTB1651CWN	SRTB1641CWN

### Height 1768 mm

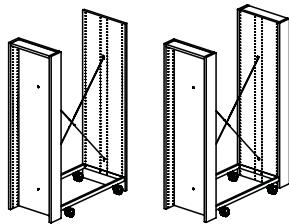

Module mm	Shelf depth mm	Item no. 1 of each end panel	Item no. 2 func. end panels
500	250	SRTB1651ARM	SRTB1641ARM
500	300	SRTB1651ARN	SRTB1641ARN
750	250	SRTB1651ASM	SRTB1641ASM
750	300	SRTB1651ASN	SRTB1641ASN
900	250	SRTB1651AUM	SRTB1641AUM
900	300	SRTB1651AUN	SRTB1641AUN
1000	250	SRTB1651AWM	SRTB1641AWM
1000	300	SRTB1651AWN	SRTB1641AWN

# RATIO SHELVING

## SINGLE-SIDED - BACK FRAME

The starter bay includes two end panels (with holes on the inside), back frame and fittings. The add-on bay includes one intermediate panel (with holes on both sides), back frame and fittings. For shelves and functions, see from page 43.

### Height 1096 mm

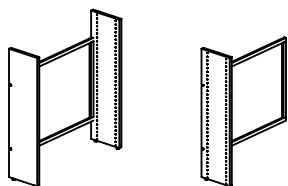

Module mm	Shelf depth mm	Item no. Starter bay	● ■	Item no. Add-on bay	● ■
500	250	SRTB1113GRM		SRTB1213GRM	
500	300	SRTB1113GRN		SRTB1213GRN	
750	250	SRTB1113GSM		SRTB1213GSM	
750	300	SRTB1113GSN		SRTB1213GSN	
900	250	SRTB1113GUM		SRTB1213GUM	
900	300	SRTB1113GUN		SRTB1213GUN	
1000	250	SRTB1113GWM		SRTB1213GWM	
1000	300	SRTB1113GWN		SRTB1213GWN	

### Height 1512 mm

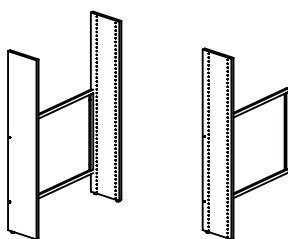

Module mm	Shelf depth mm	Item no. Starter bay	● ■	Item no. Add-on bay	● ■
500	250	SRTB1113CRM		SRTB1213CRM	
500	300	SRTB1113CRN		SRTB1213CRN	
750	250	SRTB1113CSM		SRTB1213CSM	
750	300	SRTB1113CSN		SRTB1213CSN	
900	250	SRTB1113CUM		SRTB1213CUM	
900	300	SRTB1113CUN		SRTB1213CUN	
1000	250	SRTB1113CWM		SRTB1213CWM	
1000	300	SRTB1113CWN		SRTB1213CWN	

### Height 1768 mm

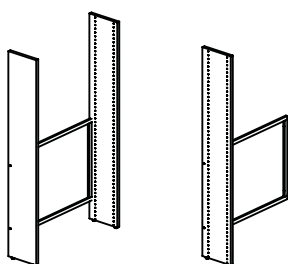

Module mm	Shelf depth mm	Item no. Starter bay	● ■	Item no. Add-on bay	● ■
500	250	SRTB1113ARM		SRTB1213ARM	
500	300	SRTB1113ARN		SRTB1213ARN	
750	250	SRTB1113ASM		SRTB1213ASM	
750	300	SRTB1113ASN		SRTB1213ASN	
900	250	SRTB1113AUM		SRTB1213AUM	
900	300	SRTB1113AUN		SRTB1213AUN	
1000	250	SRTB1113AWM		SRTB1213AWM	
1000	300	SRTB1113AWN		SRTB1213AWN	

### Height 2056 mm

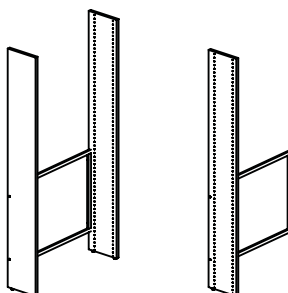

Module mm	Shelf depth mm	Item no. Starter bay	● ■	Item no. Add-on bay	● ■
500	250	SRTB1113DRM		SRTB1213DRM	
500	300	SRTB1113DRN		SRTB1213DRN	
750	250	SRTB1113DSM		SRTB1213DSM	
750	300	SRTB1113DSN		SRTB1213DSN	
900	250	SRTB1113DUM		SRTB1213DUM	
900	300	SRTB1113DUN		SRTB1213DUN	
1000	250	SRTB1113DWM		SRTB1213DWM	
1000	300	SRTB1113DWN		SRTB1213DWN	

# RATIO SHELVING

## SINGLE-SIDED - BACK FRAME

The starter bay includes two end panels (with holes on the inside), back frame and fittings. The add-on bay includes one intermediate panel (with holes on both sides), back frame and fittings. For shelves and functions, see from page 43.

Height 2248 mm

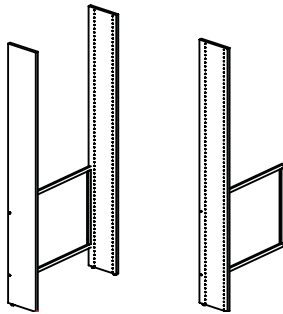

Module mm	Shelf depth mm	Item no. Starter bay	● ■	Item no. Add-on bay	● ■
500	250	SRTB1113ERM		SRTB1213ERM	
500	300	SRTB1113ERN		SRTB1213ERN	
750	250	SRTB1113ESM		SRTB1213ESM	
750	300	SRTB1113ESN		SRTB1213ESN	
900	250	SRTB1113EUM		SRTB1213EUM	
900	300	SRTB1113EUN		SRTB1213EUN	
1000	250	SRTB1113EWM		SRTB1213EWM	
1000	300	SRTB1113EWN		SRTB1213EWN	

# RATIO SHELVING

## DOUBLE-SIDED - BACK FRAME

The starter bay includes two end panels (with holes on the inside), back frame and fittings. The add-on bay includes one intermediate panel (with holes on both sides), back frame and fittings. For shelves and functions, see from page 43.

### Height 1096 mm

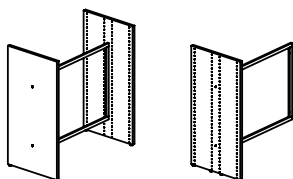

Module mm	Shelf depth mm	Item no. Starter bay	● ■	Item no. Add-on bay	● ■
500	250	SRTB1313GRM		SRTB1413GRM	
500	300	SRTB1313GRN		SRTB1413GRN	
750	250	SRTB1313GSM		SRTB1413GSM	
750	300	SRTB1313GSN		SRTB1413GSN	
900	250	SRTB1313GUM		SRTB1413GUM	
900	300	SRTB1313GUN		SRTB1413GUN	
1000	250	SRTB1313GWM		SRTB1413GWM	
1000	300	SRTB1313GWN		SRTB1413GWN	

### Height 1512 mm

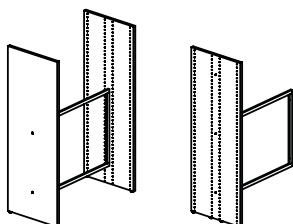

Module mm	Shelf depth mm	Item no. Starter bay	● ■	Item no. Add-on bay	● ■
500	250	SRTB1313CRM		SRTB1413CRM	
500	300	SRTB1313CRN		SRTB1413CRN	
750	250	SRTB1313CSM		SRTB1413CSM	
750	300	SRTB1313CSN		SRTB1413CSN	
900	250	SRTB1313CUM		SRTB1413CUM	
900	300	SRTB1313CUN		SRTB1413CUN	
1000	250	SRTB1313CWM		SRTB1413CWM	
1000	300	SRTB1313CWN		SRTB1413CWN	

### Height 1768 mm

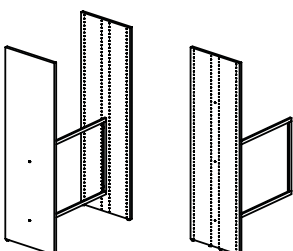

Module mm	Shelf depth mm	Item no. Starter bay	● ■	Item no. Add-on bay	● ■
500	250	SRTB1313ARM		SRTB1413ARM	
500	300	SRTB1313ARN		SRTB1413ARN	
750	250	SRTB1313ASM		SRTB1413ASM	
750	300	SRTB1313ASN		SRTB1413ASN	
900	250	SRTB1313AUM		SRTB1413AUM	
900	300	SRTB1313AUN		SRTB1413AUN	
1000	250	SRTB1313AWM		SRTB1413AWM	
1000	300	SRTB1313AWN		SRTB1413AWN	

### Height 2056 mm

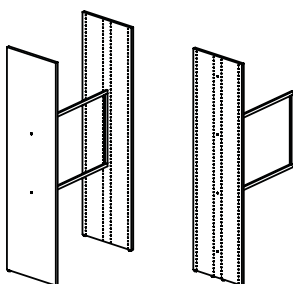

Module mm	Shelf depth mm	Item no. Starter bay	● ■	Item no. Add-on bay	● ■
500	250	SRTB1313DRM		SRTB1413DRM	
500	300	SRTB1313DRN		SRTB1413DRN	
750	250	SRTB1313DSM		SRTB1413DSM	
750	300	SRTB1313DSN		SRTB1413DSN	
900	250	SRTB1313DUM		SRTB1413DUM	
900	300	SRTB1313DUN		SRTB1413DUN	
1000	250	SRTB1313DWM		SRTB1413DWM	
1000	300	SRTB1313DWN		SRTB1413DWN	

# RATIO SHELVING

## DOUBLE-SIDED - BACK FRAME

The starter bay includes two end panels (with holes on the inside), back frame and fittings. The add-on bay includes one intermediate panel (with holes on both sides), back frame and fittings. For shelves and functions, see from page 43.

Height 2248 mm

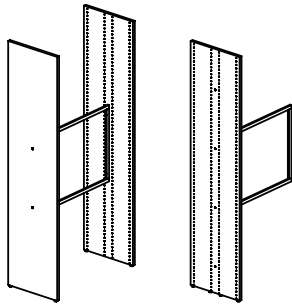

Module mm	Shelf depth mm	Item no. Starter bay	● ■	Item no. Add-on bay	● ■
500	250	SRTB1313ERM		SRTB1413ERM	
500	300	SRTB1313ERN		SRTB1413ERN	
750	250	SRTB1313ESM		SRTB1413ESM	
750	300	SRTB1313ESN		SRTB1413ESN	
900	250	SRTB1313EUM		SRTB1413EUM	
900	300	SRTB1313EUN		SRTB1413EUN	
1000	250	SRTB1313EWM		SRTB1413EWM	
1000	300	SRTB1313EWN		SRTB1413EWN	

### Back frame for extra stability for 2056 and 2248 mm double-sided configurations

Additional back frame can be added to starter bay and following add-on bays for extra stability. See overview below on how to place back frame for one or more bays. One back frame is included per bay. Additional back frames must be ordered separately.



Module mm	Item no.
500	SRTB8931ORO
750	SRTB8931OSO
900	SRTB8931OUO
1000	SRTB8931OWO

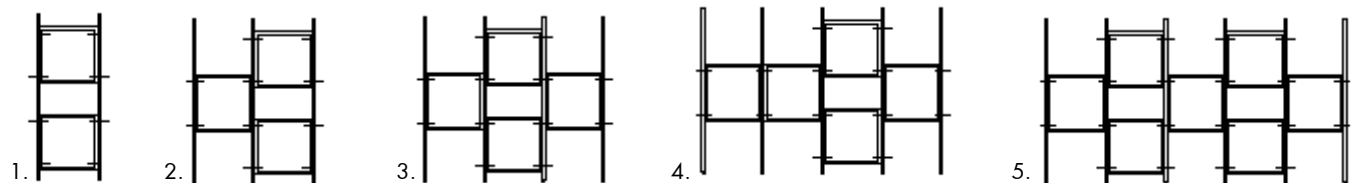

- |                                  |                                |
|----------------------------------|--------------------------------|
| 1. Starter bay                   | Order 1 additional back frame  |
| 2. Starter bay and 1 add-on bay  | Order 1 additional back frame  |
| 3. Starter bay and 2 add-on bays | Order 1 additional back frame  |
| 4. Starter bay and 3 add-on bays | Order 1 additional back frame  |
| 5. Starter bay and 4 add-on bays | Order 2 additional back frames |

# RATIO SHELVING

## SINGLE- & DOUBLE-SIDED - BACK FRAME - HIGH INTERMEDIATE PANEL

To be used in between standard end panels to create different design/look. The add-on bay includes one intermediate panel (with holes on both sides), back frame and fittings. For shelves and functions, see from page 43.

### Height 1096 mm

H1396 x D337/387 or D640/740 mm. The panel is 300 mm higher than the standard 1096 mm panel and 50/100 mm deeper.

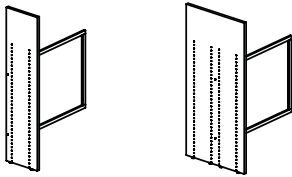

Module mm	Shelf depth mm	Item no. Single-sided	● ■	Item no. Double-sided	● ■
500	250	SRTB1253GRM		SRTB1453GRM	
500	300	SRTB1253GRN		SRTB1453GRN	
750	250	SRTB1253GSM		SRTB1453GSM	
750	300	SRTB1253GSN		SRTB1453GSN	
900	250	SRTB1253GUM		SRTB1453GUM	
900	300	SRTB1253GUN		SRTB1453GUN	
1000	250	SRTB1253GWM		SRTB1453GWM	
1000	300	SRTB1253GWN		SRTB1453GWN	

### Height 1512 mm

H1812 x D337/387 or D640/740 mm. The panel is 300 mm higher than the standard 1512 mm panel and 50/100 mm deeper.

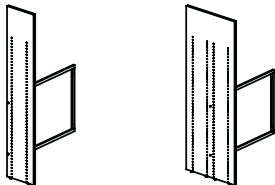

Module mm	Shelf depth mm	Item no. Single-sided	● ■	Item no. Double-sided	● ■
500	250	SRTB1253CRM		SRTB1453CRM	
500	300	SRTB1253CRN		SRTB1453CRN	
750	250	SRTB1253CSM		SRTB1453CSM	
750	300	SRTB1253CSN		SRTB1453CSN	
900	250	SRTB1253CUM		SRTB1453CUM	
900	300	SRTB1253CUN		SRTB1453CUN	
1000	250	SRTB1253CWM		SRTB1453CWM	
1000	300	SRTB1253CWN		SRTB1453CWN	

### Height 1768 mm

H2068 x D337/387 or D640/740 mm. The panel is 300 mm higher than the standard 1768 mm panel and 50/100 mm deeper.

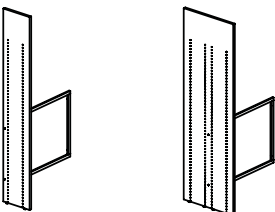

Module mm	Shelf depth mm	Item no. Single-sided	● ■	Item no. Double-sided	● ■
500	250	SRTB1253ARM		SRTB1453ARM	
500	300	SRTB1253ARN		SRTB1453ARN	
750	250	SRTB1253ASM		SRTB1453ASM	
750	300	SRTB1253ASN		SRTB1453ASN	
900	250	SRTB1253AUM		SRTB1453AUM	
900	300	SRTB1253AUN		SRTB1453AUN	
1000	250	SRTB1253AWM		SRTB1453AWM	
1000	300	SRTB1253AWN		SRTB1453AWN	

# RATIO SHELVING

## DOUBLE-SIDED - BACK FRAME - STANDARD END PANELS - CASTORS

The starter bay includes two end panels (with holes on the inside), back frame, fittings and castors (4 standard, hard castors without brakes). The add-on bay includes one intermediate panel (with holes on both sides), back frame, fittings and castors (as above). Castors are available as hard/soft and with/without brakes. For shelves and functions, see from page 43.

### Height 1096 mm

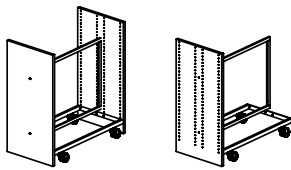

Module mm	Shelf depth mm	Item no. Starter bay	● ■	Item no. Add-on bay	● ■
500	250	SRTB1613GRM		SRTB1713GRM	
500	300	SRTB1613GRN		SRTB1713GRN	
750	250	SRTB1613GSM		SRTB1713GSM	
750	300	SRTB1613GSN		SRTB1713GSN	
900	250	SRTB1613GUM		SRTB1713GUM	
900	300	SRTB1613GUN		SRTB1713GUN	
1000	250	SRTB1613GWM		SRTB1713GWM	
1000	300	SRTB1613GWN		SRTB1713GWN	

### Height 1512 mm

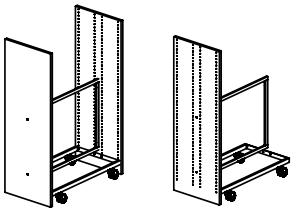

Module mm	Shelf depth mm	Item no. Starter bay	● ■	Item no. Add-on bay	● ■
500	250	SRTB1613CRM		SRTB1713CRM	
500	300	SRTB1613CRN		SRTB1713CRN	
750	250	SRTB1613CSM		SRTB1713CSM	
750	300	SRTB1613CSN		SRTB1713CSN	
900	250	SRTB1613CUM		SRTB1713CUM	
900	300	SRTB1613CUN		SRTB1713CUN	
1000	250	SRTB1613CWM		SRTB1713CWM	
1000	300	SRTB1613CWN		SRTB1713CWN	

### Height 1768 mm

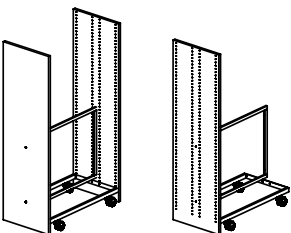

Module mm	Shelf depth mm	Item no. Starter bay	● ■	Item no. Add-on bay	● ■
500	250	SRTB1613ARM		SRTB1713ARM	
500	300	SRTB1613ARN		SRTB1713ARN	
750	250	SRTB1613ASM		SRTB1713ASM	
750	300	SRTB1613ASN		SRTB1713ASN	
900	250	SRTB1613AUM		SRTB1713AUM	
900	300	SRTB1613AUN		SRTB1713AUN	
1000	250	SRTB1613AWM		SRTB1713AWM	
1000	300	SRTB1613AWN		SRTB1713AWN	

# RATIO SHELVING

## DOUBLE-SIDED - BACK FRAME - STANDARD AND FUNCTIONAL END PANELS

For display. Choose between 1 standard and 1 functional end panel or 2 functional end panels. A complete bay includes two end panels (with holes on the inside), back frame and fittings. For shelves and functions for the bays, see from page 43. For accessories for the functional end panels, see page 60.

### Height 1096 mm

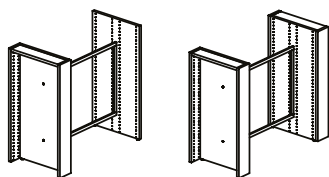

Module mm	Shelf depth mm	Item no. 1 of each end panel	Item no. 2 func. end panels
500	250	SRTB1353GRM	SRTB1343GRM
500	300	SRTB1353GRN	SRTB1343GRN
750	250	SRTB1353GSM	SRTB1343GSM
750	300	SRTB1353GSN	SRTB1343GSN
900	250	SRTB1353GUM	SRTB1343GUM
900	300	SRTB1353GUN	SRTB1343GUN
1000	250	SRTB1353GWM	SRTB1343GWM
1000	300	SRTB1353GWN	SRTB1343GWN

### Height 1512 mm

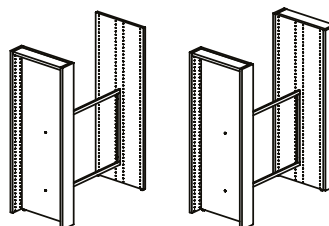

Module mm	Shelf depth mm	Item no. 1 of each end panel	Item no. 2 func. end panels
500	250	SRTB1353CRM	SRTB1343CRM
500	300	SRTB1353CRN	SRTB1343CRN
750	250	SRTB1353CSM	SRTB1343CSM
750	300	SRTB1353CSN	SRTB1343CSN
900	250	SRTB1353CUM	SRTB1343CUM
900	300	SRTB1353CUN	SRTB1343CUN
1000	250	SRTB1353CWM	SRTB1343CWM
1000	300	SRTB1353CWN	SRTB1343CWN

### Height 1768 mm

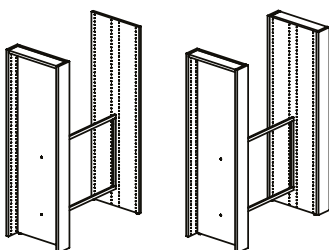

Module mm	Shelf depth mm	Item no. 1 of each end panel	Item no. 2 func. end panels
500	250	SRTB1353ARM	SRTB1343ARM
500	300	SRTB1353ARN	SRTB1343ARN
750	250	SRTB1353ASM	SRTB1343ASM
750	300	SRTB1353ASN	SRTB1343ASN
900	250	SRTB1353AUM	SRTB1343AUM
900	300	SRTB1353AUN	SRTB1343AUN
1000	250	SRTB1353AWM	SRTB1343AWM
1000	300	SRTB1353AWN	SRTB1343AWN

### Height 2056 mm

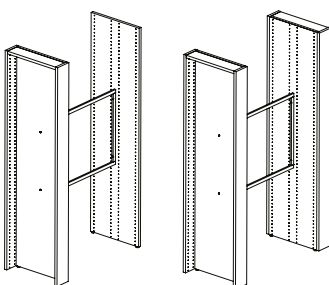

Module mm	Shelf depth mm	Item no. 1 of each end panel	Item no. 2 func. end panels
500	250	SRTB1353DRM	SRTB1343DRM
500	300	SRTB1353DRN	SRTB1343DRN
750	250	SRTB1353DSM	SRTB1343DSM
750	300	SRTB1353DSN	SRTB1343DSN
900	250	SRTB1353DUM	SRTB1343DUM
900	300	SRTB1353DUN	SRTB1343DUN
1000	250	SRTB1353DWM	SRTB1343DWM
1000	300	SRTB1353DWN	SRTB1343DWN



# RATIO SHELVING

## DOUBLE-SIDED - BACK FRAME - STANDARD AND FUNCTIONAL END PANELS

For display. Choose between 1 standard and 1 functional end panel or 2 functional end panels. A complete bay includes two end panels (with holes on the inside), back frame and fittings. For shelves and functions for the bays, see from page 43. For accessories for the functional end panels, see page 60.

Height 2248 mm

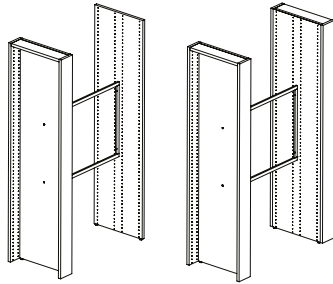

Module mm	Shelf depth mm	Item no. 1 of each end panel	● ■	Item no. 2 func. end panels	● ■
500	250	SRTB1353ERM		SRTB1343ERM	
500	300	SRTB1353ERN		SRTB1343ERN	
750	250	SRTB1353ESM		SRTB1343ESM	
750	300	SRTB1353ESN		SRTB1343ESN	
900	250	SRTB1353EUM		SRTB1343EUM	
900	300	SRTB1353EUN		SRTB1343EUN	
1000	250	SRTB1353EWM		SRTB1343EWM	
1000	300	SRTB1353EWN		SRTB1343EWN	

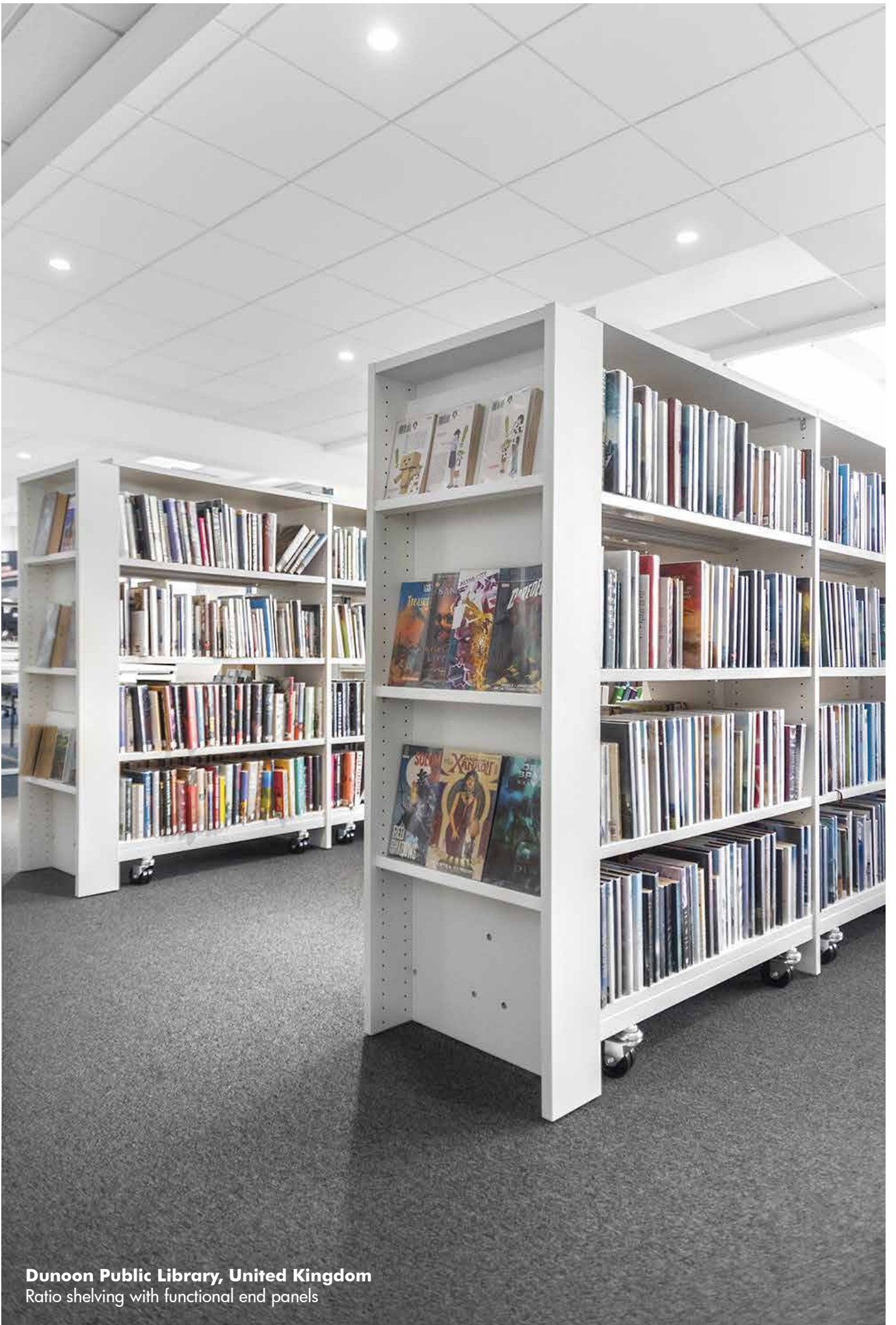

**Dunoon Public Library, United Kingdom**  
Ratio shelving with functional end panels

# RATIO SHELVING

## DOUBLE-SIDED - BACK FRAME - STANDARD AND FUNCTIONAL END PANELS WITH CASTORS

For display. Choose between 1 standard and 1 functional end panel or 2 functional end panels. A complete bay includes two end panels (with holes on the inside), back frame, fittings and castors (4 standard, hard castors without brakes). For shelves and functions for the bays, see from page 43. For accessories for the functional end panels, see page 60.

### Height 1096 mm

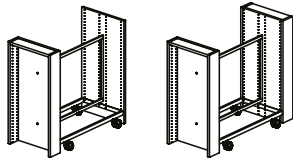

Module mm	Shelf depth mm	Item no. 1 of each end panel	Item no. 2 func. end panels
500	250	SRTB1653GRM	SRTB1643GRM
500	300	SRTB1653GRN	SRTB1643GRN
750	250	SRTB1653GSM	SRTB1643GSM
750	300	SRTB1653GSN	SRTB1643GSN
900	250	SRTB1653GUM	SRTB1643GUM
900	300	SRTB1653GUN	SRTB1643GUN
1000	250	SRTB1653GWM	SRTB1643GWM
1000	300	SRTB1653GWN	SRTB1643GWN

### Height 1512 mm

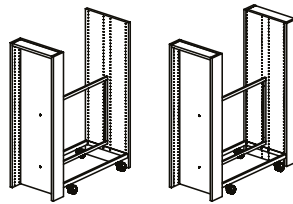

Module mm	Shelf depth mm	Item no. 1 of each end panel	Item no. 2 func. end panels
500	250	SRTB1653CRM	SRTB1643CRM
500	300	SRTB1653CRN	SRTB1643CRN
750	250	SRTB1653CSM	SRTB1643CSM
750	300	SRTB1653CSN	SRTB1643CSN
900	250	SRTB1653CUM	SRTB1643CUM
900	300	SRTB1653CUN	SRTB1643CUN
1000	250	SRTB1653CWM	SRTB1643CWM
1000	300	SRTB1653CWN	SRTB1643CWN

### Height 1768 mm

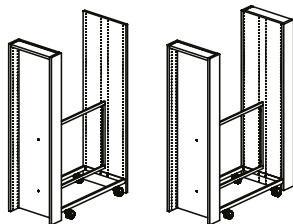

Module mm	Shelf depth mm	Item no. 1 of each end panel	Item no. 2 func. end panels
500	250	SRTB1653ARM	SRTB1643ARM
500	300	SRTB1653ARN	SRTB1643ARN
750	250	SRTB1653ASM	SRTB1643ASM
750	300	SRTB1653ASN	SRTB1643ASN
900	250	SRTB1653AUM	SRTB1643AUM
900	300	SRTB1653AUN	SRTB1643AUN
1000	250	SRTB1653AWM	SRTB1643AWM
1000	300	SRTB1653AWN	SRTB1643AWN

### Height 2056 mm

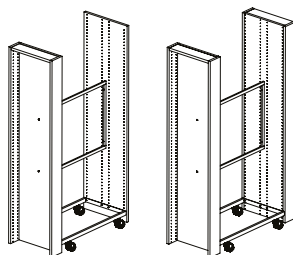

Module mm	Shelf depth mm	Item no. 1 of each end panel	Item no. 2 func. end panels
500	250	SRTB1653DRM	SRTB1643DRM
500	300	SRTB1653DRN	SRTB1643DRN
750	250	SRTB1653DSM	SRTB1643DSM
750	300	SRTB1653DSN	SRTB1643DSN
900	250	SRTB1653DUM	SRTB1643DUM
900	300	SRTB1653DUN	SRTB1643DUN
1000	250	SRTB1653DWM	SRTB1643DWM
1000	300	SRTB1653DWN	SRTB1643DWN

# RATIO SHELVING

## SINGLE-SIDED - BACK PANEL

The starter bay includes two end panels (with holes on the inside), back panel and fittings. The add-on bay includes one intermediate panel (with holes on both sides), back panel and fittings. For shelves and functions, see from page 43.

### Height 1096 mm

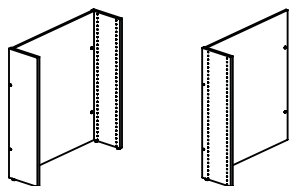

Module mm	Shelf depth mm	Item no. Starter bay	Item no. Add-on bay
500	250	SRTB1112GRM	SRTB1112GRM
500	300	SRTB1112GRN	SRTB1212GRN
750	250	SRTB1112GSM	SRTB1212GSM
750	300	SRTB1112GSN	SRTB1212GSN
900	250	SRTB1112GUM	SRTB1212GUM
900	300	SRTB1112GUN	SRTB1212GUN
1000	250	SRTB1112GWM	SRTB1212GWM
1000	300	SRTB1112GWN	SRTB1212GWN

### Height 1512 mm

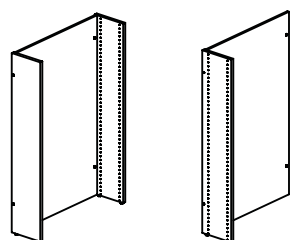

Module mm	Shelf depth mm	Item no. Starter bay	Item no. Add-on bay
500	250	SRTB1112CRM	SRTB1112CRM
500	300	SRTB1112CRN	SRTB1212CRN
750	250	SRTB1112CSM	SRTB1212CSM
750	300	SRTB1112CSN	SRTB1212CSN
900	250	SRTB1112CUM	SRTB1212CUM
900	300	SRTB1112CUN	SRTB1212CUN
1000	250	SRTB1112CWM	SRTB1212CWM
1000	300	SRTB1112CWN	SRTB1212CWN

### Height 1768 mm

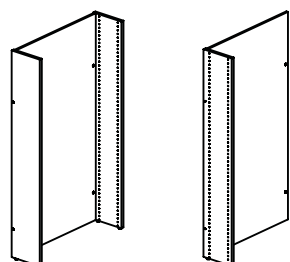

Module mm	Shelf depth mm	Item no. Starter bay	Item no. Add-on bay
500	250	SRTB1112ARM	SRTB1212ARM
500	300	SRTB1112ARN	SRTB1212ARN
750	250	SRTB1112ASM	SRTB1212ASM
750	300	SRTB1112ASN	SRTB1212ASN
900	250	SRTB1112AUM	SRTB1212AUM
900	300	SRTB1112AUN	SRTB1212AUN
1000	250	SRTB1112AWM	SRTB1212AWM
1000	300	SRTB1112AWN	SRTB1212AWN

### Height 2056 mm

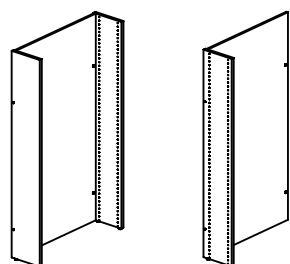

Module mm	Shelf depth mm	Item no. Starter bay	Item no. Add-on bay
500	250	SRTB1112DRM	SRTB1212DRM
500	300	SRTB1112DRN	SRTB1212DRN
750	250	SRTB1112DSM	SRTB1212DSM
750	300	SRTB1112DSN	SRTB1212DSN
900	250	SRTB1112DUM	SRTB1212DUM
900	300	SRTB1112DUN	SRTB1212DUN
1000	250	SRTB1112DWM	SRTB1212DWM
1000	300	SRTB1112DWN	SRTB1212DWN

# RATIO SHELVING

## SINGLE-SIDED - BACK PANEL

The starter bay includes two end panels (with holes on the inside), back panel and fittings. The add-on bay includes one intermediate panel (with holes on both sides), back panel and fittings. For shelves and functions, see from page 43.

Height 2248 mm

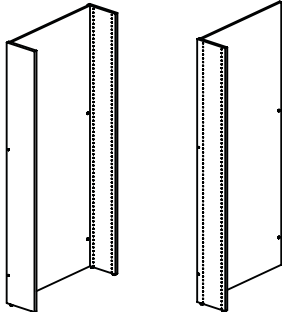

Module mm	Shelf depth mm	Item no. Starter bay	■	Item no. Add-on bay	■
500	250	SRTB1112ERM		SRTB1212ERM	
500	300	SRTB1112ERN		SRTB1212ERN	
750	250	SRTB1112ESM		SRTB1212ESM	
750	300	SRTB1112ESN		SRTB1212ESN	
900	250	SRTB1112EUM		SRTB1212EUM	
900	300	SRTB1112EUN		SRTB1212EUN	
1000	250	SRTB1112EWM		SRTB1212EWM	
1000	300	SRTB1112EWN		SRTB1212EWN	

# RATIO SHELVING

## DOUBLE-SIDED - BACK PANEL

The starter bay includes two end panels (with holes on the inside), back panel and fittings. The add-on bay includes one intermediate panel (with holes on both sides), back panel and fittings. For shelves and functions, see from page 43.

### Height 1096 mm

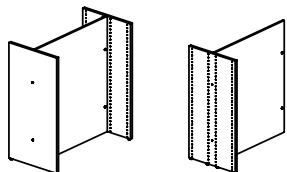

Module mm	Shelf depth mm	Item no. Starter bay	Item no. Add-on bay
500	250	SRTB1312GRM	SRTB1412GRM
500	300	SRTB1312GRN	SRTB1412GRN
750	250	SRTB1312GSM	SRTB1412GSM
750	300	SRTB1312GSN	SRTB1412GSN
900	250	SRTB1312GUM	SRTB1412GUM
900	300	SRTB1312GUN	SRTB1412GUN
1000	250	SRTB1312GWM	SRTB1412GWM
1000	300	SRTB1312GWN	SRTB1412GWN

### Height 1512 mm

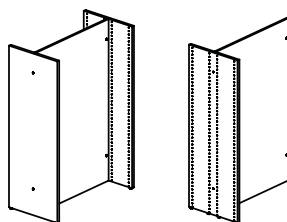

Module mm	Shelf depth mm	Item no. Starter bay	Item no. Add-on bay
500	250	SRTB1312CRM	SRTB1412CRM
500	300	SRTB1312CRN	SRTB1412CRN
750	250	SRTB1312CSM	SRTB1412CSM
750	300	SRTB1312CSN	SRTB1412CSN
900	250	SRTB1312CUM	SRTB1412CUM
900	300	SRTB1312CUN	SRTB1412CUN
1000	250	SRTB1312CWM	SRTB1412CWM
1000	300	SRTB1312CWN	SRTB1412CWN

### Height 1768 mm

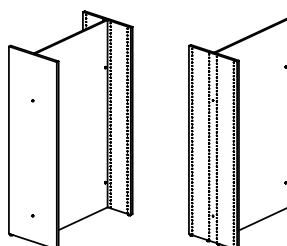

Module mm	Shelf depth mm	Item no. Starter bay	Item no. Add-on bay
500	250	SRTB1312ARM	SRTB1412ARM
500	300	SRTB1312ARN	SRTB1412ARN
750	250	SRTB1312ASM	SRTB1412ASM
750	300	SRTB1312ASN	SRTB1412ASN
900	250	SRTB1312AUM	SRTB1412AUM
900	300	SRTB1312AUN	SRTB1412AUN
1000	250	SRTB1312AWM	SRTB1412AWM
1000	300	SRTB1312AWN	SRTB1412AWN

### Height 2056 mm

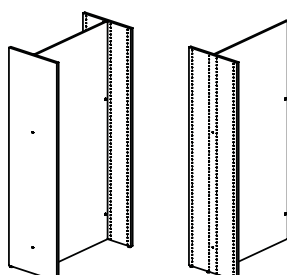

Module mm	Shelf depth mm	Item no. Starter bay	Item no. Add-on bay
500	250	SRTB1312DRM	SRTB1412DRM
500	300	SRTB1312DRN	SRTB1412DRN
750	250	SRTB1312DSM	SRTB1412DSM
750	300	SRTB1312DSN	SRTB1412DSN
900	250	SRTB1312DUM	SRTB1412DUM
900	300	SRTB1312DUN	SRTB1412DUN
1000	250	SRTB1312DWM	SRTB1412DWM
1000	300	SRTB1312DWN	SRTB1412DWN

# RATIO SHELVING

## DOUBLE-SIDED - BACK PANEL

The starter bay includes two end panels (with holes on the inside), back panel and fittings. The add-on bay includes one intermediate panel (with holes on both sides), back panel and fittings. For shelves and functions, see from page 43.

Height 2248 mm

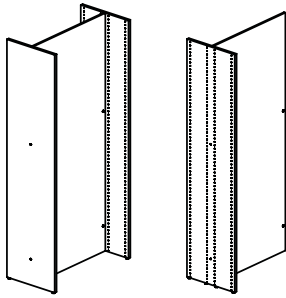

Module mm	Shelf depth mm	Item no. Starter bay	■	Item no. Add-on bay	■
500	250	SRTB1312ERM		SRTB1412ERM	
500	300	SRTB1312ERN		SRTB1412ERN	
750	250	SRTB1312ESM		SRTB1412ESM	
750	300	SRTB1312ESN		SRTB1412ESN	
900	250	SRTB1312EUM		SRTB1412EUM	
900	300	SRTB1312EUN		SRTB1412EUN	
1000	250	SRTB1312EWM		SRTB1412EWM	
1000	300	SRTB1312EWN		SRTB1412EWN	

# RATIO SHELVING

## SINGLE- AND DOUBLE-SIDED - BACK PANEL - HIGH INTERMEDIATE PANEL

To be used in between standard end panels to create different design/look. The add-on bay includes one intermediate panel (with holes on both sides), back panel and fittings. For shelves and functions, see from page 43.

### Height 1096 mm

H1396 x D337/387 or D640/740 mm. The panel is 300 mm higher than the standard 1096 mm panel and 50/100 mm deeper.

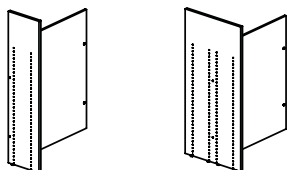

Module mm	Shelf depth mm	Item no. Single-sided	Item no. Double-sided
500	250	SRTB1252GRM	SRTB1452GRM
500	300	SRTB1252GRN	SRTB1452GRN
750	250	SRTB1252GSM	SRTB1452GSM
750	300	SRTB1252GSN	SRTB1452GSN
900	250	SRTB1252GUM	SRTB1452GUM
900	300	SRTB1252GUN	SRTB1452GUN
1000	250	SRTB1252GWM	SRTB1452GWM
1000	300	SRTB1252GWN	SRTB1452GWN

### Height 1512 mm

H1812 x D337/387 or D640/740 mm. The panel is 300 mm higher than the standard 1512 mm panel and 50/100 mm deeper.

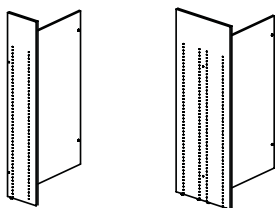

Module mm	Shelf depth mm	Item no. Single-sided	Item no. Double-sided
500	250	SRTB1252CRM	SRTB1452CRM
500	300	SRTB1252CRN	SRTB1452CRN
750	250	SRTB1252CSM	SRTB1452CSM
750	300	SRTB1252CSN	SRTB1452CSN
900	250	SRTB1252CUM	SRTB1452CUM
900	300	SRTB1252CUN	SRTB1452CUN
1000	250	SRTB1252CWM	SRTB1452CWM
1000	300	SRTB1252CWN	SRTB1452CWN

### Height 1768 mm

H2068 x D337/387 or D640/740 mm. The panel is 300 mm higher than the standard 1768 mm panel and 50/100 mm deeper.

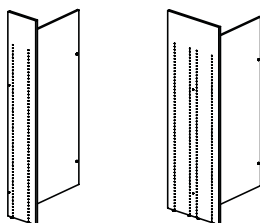

Module mm	Shelf depth mm	Item no. Single-sided	Item no. Double-sided
500	250	SRTB1252ARM	SRTB1452ARM
500	300	SRTB1252ARN	SRTB1452ARN
750	250	SRTB1252ASM	SRTB1452ASM
750	300	SRTB1252ASN	SRTB1452ASN
900	250	SRTB1252AUM	SRTB1452AUM
900	300	SRTB1252AUN	SRTB1452AUN
1000	250	SRTB1252AWM	SRTB1452AWM
1000	300	SRTB1252AWN	SRTB1452AWN



# RATIO SHELVING

## DOUBLE-SIDED - BACK PANEL - CASTORS

The starter bay includes two end panels (with holes on the inside), back panel, fittings and castors (4 standard, hard castors, without brakes). The add-on bay includes one intermediate panel (with holes on both sides), back panel, fittings and castors (as above). Castors are available as hard/soft and with/without brakes. For shelves and functions, see from page 43.

### Height 1096 mm

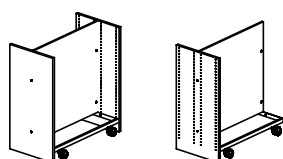

Module mm	Shelf depth mm	Item no. Starter bay	● ■	Item no. Add-on bay	● ■
500	250	SRTB1612GRM		SRTB1712GRM	
500	300	SRTB1612GRN		SRTB1712GRN	
750	250	SRTB1612GSM		SRTB1712GSM	
750	300	SRTB1612GSN		SRTB1712GSN	
900	250	SRTB1612GUM		SRTB1712GUM	
900	300	SRTB1612GUN		SRTB1712GUN	
1000	250	SRTB1612GWM		SRTB1712GWM	
1000	300	SRTB1612GWN		SRTB1712GWN	

### Height 1512 mm

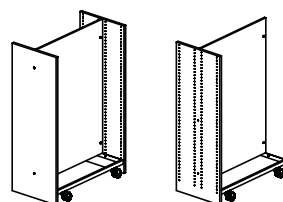

Module mm	Shelf depth mm	Item no. Starter bay	● ■	Item no. Add-on bay	● ■
500	250	SRTB1612CRM		SRTB1712CRM	
500	300	SRTB1612CRN		SRTB1712CRN	
750	250	SRTB1612CSM		SRTB1712CSM	
750	300	SRTB1612CSN		SRTB1712CSN	
900	250	SRTB1612CUM		SRTB1712CUM	
900	300	SRTB1612CUN		SRTB1712CUN	
1000	250	SRTB1612CWM		SRTB1712CWM	
1000	300	SRTB1612CWN		SRTB1712CWN	

### Height 1768 mm

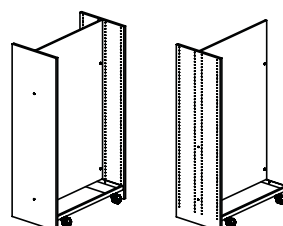

Module mm	Shelf depth mm	Item no. Starter bay	● ■	Item no. Add-on bay	● ■
500	250	SRTB1612ARM		SRTB1712ARM	
500	300	SRTB1612ARN		SRTB1712ARN	
750	250	SRTB1612ASM		SRTB1712ASM	
750	300	SRTB1612ASN		SRTB1712ASN	
900	250	SRTB1612AUM		SRTB1712AUM	
900	300	SRTB1612AUN		SRTB1712AUN	
1000	250	SRTB1612AWM		SRTB1712AWM	
1000	300	SRTB1612AWN		SRTB1712AWN	

### Height 2056 mm

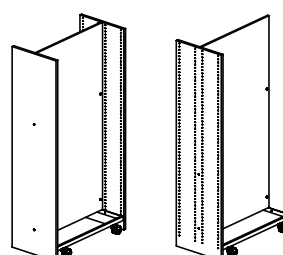

Module mm	Shelf depth mm	Item no. Starter bay	● ■	Item no. Add-on bay	● ■
500	250	SRTB1612DRM		SRTB1712DRM	
500	300	SRTB1612DRN		SRTB1712DRN	
750	250	SRTB1612DSM		SRTB1712DSM	
750	300	SRTB1612DSN		SRTB1712DSN	
900	250	SRTB1612DUM		SRTB1712DUM	
900	300	SRTB1612DUN		SRTB1712DUN	
1000	250	SRTB1612DWM		SRTB1712DWM	
1000	300	SRTB1612DWN		SRTB1712DWN	

# RATIO SHELVING

## DOUBLE-SIDED - BACK PANEL - STANDARD AND FUNCTIONAL END PANELS

For display. Choose between 1 standard and 1 functional end panel or 2 functional end panels. A complete bay includes two end panels (with holes on the inside), back panel and fittings. For shelves and functions for the bays, see from page 43. For accessories for the functional end panels, see page 60.

### Height 1096 mm

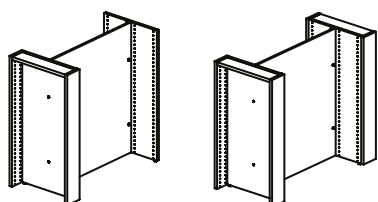

Module mm	Shelf depth mm	Item no. 1 of each end panel	Item no. 2 func. end panels
500	250	SRTB1352GRM	SRTB1342GRM
500	300	SRTB1352GRN	SRTB1342GRN
750	250	SRTB1352GSM	SRTB1342GSM
750	300	SRTB1352GSN	SRTB1342GSN
900	250	SRTB1352GUM	SRTB1342GUM
900	300	SRTB1352GUN	SRTB1342GUN
1000	250	SRTB1352GWM	SRTB1342GWM
1000	300	SRTB1352GWN	SRTB1342GWN

### Height 1512 mm

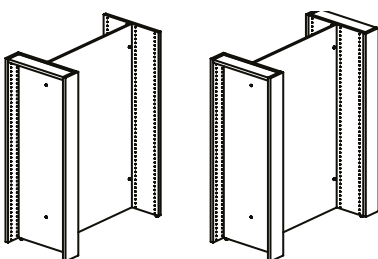

Module mm	Shelf depth mm	Item no. 1 of each end panel	Item no. 2 func. end panels
500	250	SRTB1352CRM	SRTB1342CRM
500	300	SRTB1352CRN	SRTB1342CRN
750	250	SRTB1352CSM	SRTB1342CSM
750	300	SRTB1352CSN	SRTB1342CSN
900	250	SRTB1352CUM	SRTB1342CUM
900	300	SRTB1352CUN	SRTB1342CUN
1000	250	SRTB1352CWM	SRTB1342CWM
1000	300	SRTB1352CWN	SRTB1342CWN

### Height 1768 mm

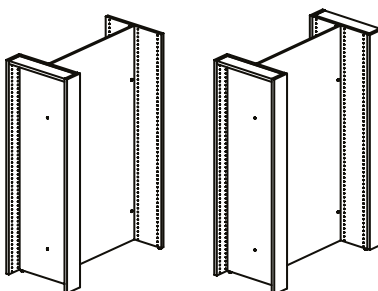

Module mm	Shelf depth mm	Item no. 1 of each end panel	Item no. 2 func. end panels
500	250	SRTB1352ARM	SRTB1342ARM
500	300	SRTB1352ARN	SRTB1342ARN
750	250	SRTB1352ASM	SRTB1342ASM
750	300	SRTB1352ASN	SRTB1342ASN
900	250	SRTB1352AUM	SRTB1342AUM
900	300	SRTB1352AUN	SRTB1342AUN
1000	250	SRTB1352AWM	SRTB1342AWM
1000	300	SRTB1352AWN	SRTB1342AWN

### Height 2056 mm

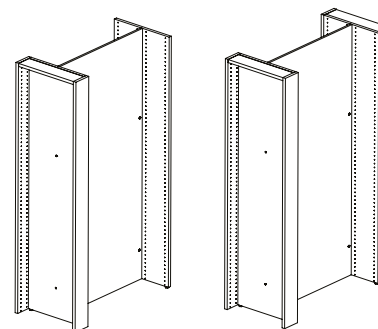

Module mm	Shelf depth mm	Item no. 1 of each end panel	Item no. 2 func. end panels
500	250	SRTB1352DRM	SRTB1342DRM
500	300	SRTB1352DRN	SRTB1342DRN
750	250	SRTB1352DSM	SRTB1342DSM
750	300	SRTB1352DSN	SRTB1342DSN
900	250	SRTB1352DUM	SRTB1342DUM
900	300	SRTB1352DUN	SRTB1342DUN
1000	250	SRTB1352DWM	SRTB1342DWM
1000	300	SRTB1352DWN	SRTB1342DWN

# RATIO SHELVING

## DOUBLE-SIDED - BACK PANEL - STANDARD AND FUNCTIONAL END PANELS

For display. Choose between 1 standard and 1 functional end panel or 2 functional end panels. A complete bay includes two end panels (with holes on the inside), back panel and fittings. For shelves and functions for the bays, see from page 43. For accessories for the functional end panels, see page 60.

Height 2248 mm

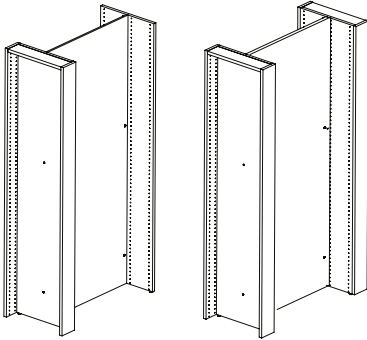

Module mm	Shelf depth mm	Item no. 1 of each end panel	Item no. 2 func. end panels
500	250	SRTB1352ERM	SRTB1342ERM
500	300	SRTB1352ERN	SRTB1342ERN
750	250	SRTB1352ESM	SRTB1342ESM
750	300	SRTB1352ESN	SRTB1342ESN
900	250	SRTB1352EUM	SRTB1342EUM
900	300	SRTB1352EUN	SRTB1342EUN
1000	250	SRTB1352EWM	SRTB1342EWM
1000	300	SRTB1352EWN	SRTB1342EWN



**Haberdashers' Aske's Girls' School, Hertfordshire, United Kingdom**  
Ratio shelving with functional end panels

# RATIO SHELVING

## DOUBLE-SIDED - BACK PANEL - STANDARD AND FUNCTIONAL END PANELS - CASTORS

For display. Choose between 1 standard and 1 functional end panel or 2 functional end panels. A complete bay includes two end panels (with holes on the inside), back panel, fittings and castors (4 standard, hard castors without brakes). For shelves and functions for the bays, see from page 43. For accessories for the functional end panels, see page 60.

### Height 1096 mm

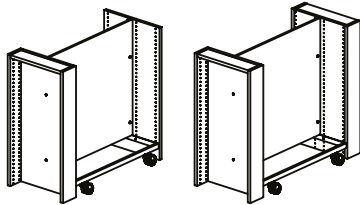

Module mm	Shelf depth mm	Item no. 1 of each end panel	Item no. 2 func. end panels
500	250	SRTB1652GRM	SRTB1642GRM
500	300	SRTB1652GRN	SRTB1642GRN
750	250	SRTB1652GSM	SRTB1642GSM
750	300	SRTB1652GSN	SRTB1642GSN
900	250	SRTB1652GUM	SRTB1642GUM
900	300	SRTB1652GUN	SRTB1642GUN
1000	250	SRTB1652GWM	SRTB1642GWM
1000	300	SRTB1652GWN	SRTB1642GWN

### Height 1512 mm

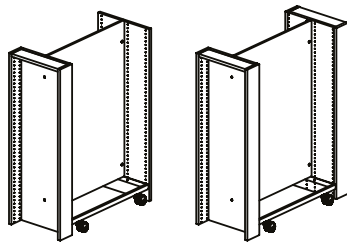

Module mm	Shelf depth mm	Item no. 1 of each end panel	Item no. 2 func. end panels
500	250	SRTB1652CRM	SRTB1642CRM
500	300	SRTB1652CRN	SRTB1642CRN
750	250	SRTB1652CSM	SRTB1642CSM
750	300	SRTB1652CSN	SRTB1642CSN
900	250	SRTB1652CUM	SRTB1642CUM
900	300	SRTB1652CUN	SRTB1642CUN
1000	250	SRTB1652CWM	SRTB1642CWM
1000	300	SRTB1652CWN	SRTB1642CWN

### Height 1768 mm

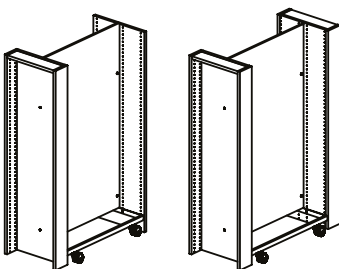

Module mm	Shelf depth mm	Item no. 1 of each end panel	Item no. 2 func. end panels
500	250	SRTB1652ARM	SRTB1642ARM
500	300	SRTB1652ARN	SRTB1642ARN
750	250	SRTB1652ASM	SRTB1642ASM
750	300	SRTB1652ASN	SRTB1642ASN
900	250	SRTB1652AUM	SRTB1642AUM
900	300	SRTB1652AUN	SRTB1642AUN
1000	250	SRTB1652AWM	SRTB1642AWM
1000	300	SRTB1652AWN	SRTB1642AWN

### Height 2056 mm

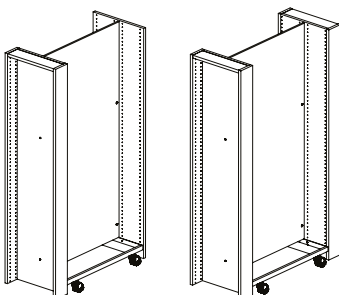

Module mm	Shelf depth mm	Item no. 1 of each end panel	Item no. 2 func. end panels
500	250	SRTB1652DRM	SRTB1642DRM
500	300	SRTB1652DRN	SRTB1642DRN
750	250	SRTB1652DSM	SRTB1642DSM
750	300	SRTB1652DSN	SRTB1642DSN
900	250	SRTB1652DUM	SRTB1642DUM
900	300	SRTB1652DUN	SRTB1642DUN
1000	250	SRTB1652DWM	SRTB1642DWM
1000	300	SRTB1652DWN	SRTB1642DWN



# SHELVES

## STEEL SHELVES

Bay H1096 mm must have 2/4 shelves (top and bottom) and bays H1512 mm or higher must have 3/6 shelves (top, intermediate and bottom) screwed into the panels for stability. The remaining shelves can be inserted via pins. The steel shelves are made of lacquered steel and can be installed with hanging book supports, see page 51.

### Steel top shelf with sign profile - for screw fixation

To be screwed into panels. Screws and plastic spacer incl. Sign profile in transparent, antireflective plastic, H50 mm. With exchangeable, humidity resistant, white label.

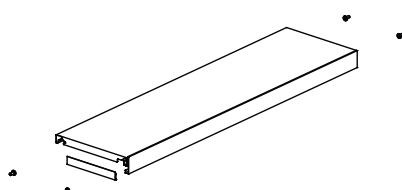

Module mm	Shelf depth mm	Item no.
500	250	SRTB2310MRO
500	300	SRTB2310NRO
750	250	SRTB2310MSO
750	300	SRTB2310NSO
900	250	SRTB2310MUO
900	300	SRTB2310NUO
1000	250	SRTB2310MW0
1000	300	SRTB2310NW0

### Steel top, intermediate and bottom shelf - for screw fixation

To be screwed into panels. Screws and plastic spacer incl.

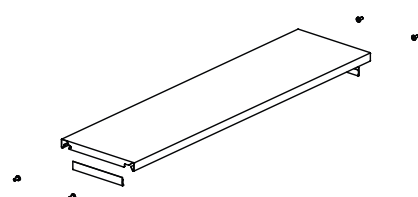

Module mm	Shelf depth mm	Item no.
500	250	SRTB2910MRO
500	300	SRTB2910NRO
750	250	SRTB2910MSO
750	300	SRTB2910NSO
900	250	SRTB2910MUO
900	300	SRTB2910NUO
1000	250	SRTB2910MW0
1000	300	SRTB2910NW0

### Steel intermediate shelf - for insertion

Shelves are not fixed and are movable. Pins incl.

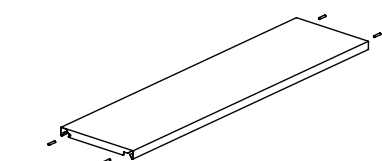

Module mm	Shelf depth mm	Item no.
500	250	SRTB2110MRO
500	300	SRTB2110NRO
750	250	SRTB2110MSO
750	300	SRTB2110NSO
900	250	SRTB2110MUO
900	300	SRTB2110NUO
1000	250	SRTB2110MW0
1000	300	SRTB2110NW0

### Steel intermediate shelf with backedge - for insertion

Shelves are not fixed and are movable. Pins incl. When turned, the shelf can be used as a sloping shelf by using the existing pins or by using bracket SRTB8010 (see page 53).

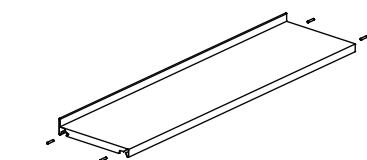

Module mm	Shelf depth mm	Item no.
500	250	SRTB2111MRO
500	300	SRTB2111NRO
750	250	SRTB2111MSO
750	300	SRTB2111NSO
900	250	SRTB2111MUO
900	300	SRTB2111NUO
1000	250	SRTB2111MW0
1000	300	SRTB2111NW0

# SHELVES

## STEEL SHELVES

Bay H1096 mm must have 2/4 shelves (top and bottom) and bays H1512 mm or higher must have 3/6 shelves (top, intermediate and bottom) screwed into the panels for stability. The remaining shelves can be inserted via pins. The steel shelves are made of lacquered steel and can be installed with hanging book supports, see page 51.

### Slanting steel shelf with high backedge - for insertion or screw fixation

Can either be inserted or screwed into panels (pins and screws included for insertion or fixation). Backedge H125mm. D180 mm.

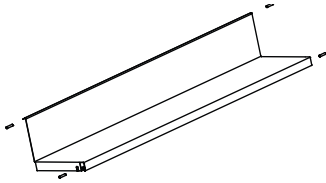

Module mm	Depth mm	Item no.
500	250	SRTB2080MRO
750	250	SRTB2080MSO
900	250	SRTB2080MUO
1000	250	SRTB2080MW0

### Steel intermediate and bottom shelf with backedge - for screw fixation

To be screwed into panels. Screws and plastic spacer incl.

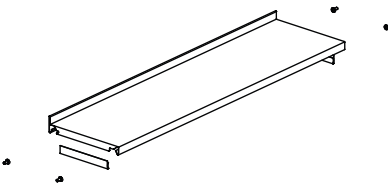

Module mm	Shelf depth mm	Item no.
500	250	SRTB2911MRO
500	300	SRTB2911NRO
750	250	SRTB2911MSO
750	300	SRTB2911NSO
900	250	SRTB2911MUO
900	300	SRTB2911NUO
1000	250	SRTB2911MW0
1000	300	SRTB2911NW0

### Steel bottom shelf with plinth - for screw fixation

To be screwed into panels. Screws and plastic spacer incl.

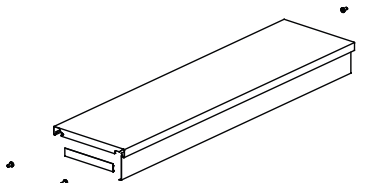

Module mm	Shelf depth mm	Item no.
500	250	SRTB2410MRO
500	300	SRTB2410NRO
750	250	SRTB2410MSO
750	300	SRTB2410NSO
900	250	SRTB2410MUO
900	300	SRTB2410NUO
1000	250	SRTB2410MW0
1000	300	SRTB2410NW0

### Steel bottom shelf with plinth and backedge - for screw fixation

To be screwed into panels. Screws and plastic spacer incl.

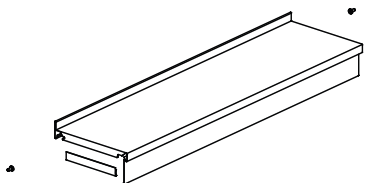

Module mm	Shelf depth mm	Item no.
500	250	SRTB2411MRO
500	300	SRTB2411NRO
750	250	SRTB2411MSO
750	300	SRTB2411NSO
900	250	SRTB2411MUO
900	300	SRTB2411NUO
1000	250	SRTB2411MW0
1000	300	SRTB2411NW0



# SHELVES

## STEEL PULL-OUT SHELVES

The pull-out shelf is installed underneath existing shelf. Allows for extra table space when browsing through books and magazines.

---

### Steel pull-out shelf

D245mm. Flush with supporting shelf. On hidden telescopic rails. For installation below steel shelves W750 mm or more.

Width mm	Shelf depth mm
600	250
600	300

Item no.



SRTB2000M00  
SRTB2000N00

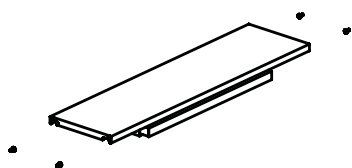

---

### Steel pull-out shelf

D295mm. Overlapping supporting shelf with 50mm. On hidden telescopic rails. For installation below steel shelves W750 mm or more.

Width mm	Shelf depth mm
600	250
600	300

Item no.



SRTB2001M00  
SRTB2001N00

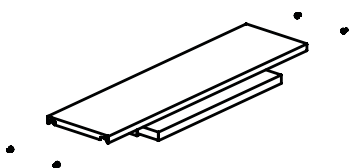

# SHELVES

## WOODEN SHELVES

Bay H1096 must have 2/4 shelves (top and bottom) and bays H1512 or higher must have 3/6 shelves (top, intermediate and bottom) screwed into the panels for stability. The remaining shelves can be inserted via pins. 500, 750 and 900 mm wooden shelves are made of particle board, 1000 mm shelves are made of blockboard (to prevent shelf from sagging). Wooden multiplex shelves with groove for hanging book support are available upon request.

### Wooden top shelf with sign profile - for screw fixation

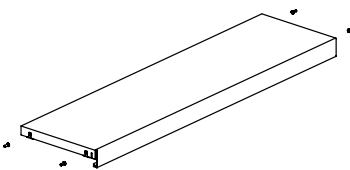
Melamine coated/veneer. To be screwed into panels. Screws incl. Sign profile in transparent, antireflective plastic, H50 mm. With exchangeable, humidity resistant, white label.	Module mm	Depth mm	Item no.	C
	500	250	SRTB2320MRO	
	500	300	SRTB2320NRO	
	750	250	SRTB2320MSO	
	750	300	SRTB2320NSO	
	900	250	SRTB2320MUO	
	900	300	SRTB2320NUO	
	1000	250	SRTB2330MW0	
	1000	300	SRTB2330NW0	

### Wooden top, intermediate and bottom shelf - for screw fixation

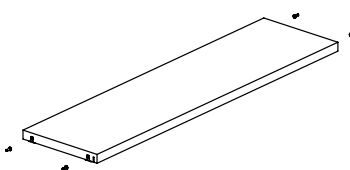
Melamine coated/veneer. To be screwed into panels. Screws incl.	Module mm	Shelf depth mm	Item no.	C
	500	250	SRTB2920MRO	
	500	300	SRTB2920NRO	
	750	250	SRTB2920MSO	
	750	300	SRTB2920NSO	
	900	250	SRTB2920MUO	
	900	300	SRTB2920NUO	
	1000	250	SRTB2930MW0	
	1000	300	SRTB2930NW0	

### Wooden intermediate shelf - for insertion

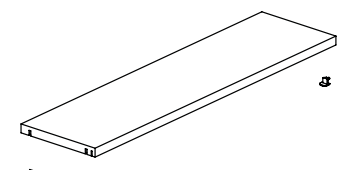
Melamine coated/veneer. Shelves are not fixed and are moveable. Pins incl.	Module mm	Depth mm	Item no.	C
	500	250	SRTB2120MRO	
	500	300	SRTB2120NRO	
	750	250	SRTB2120MSO	
	750	300	SRTB2120NSO	
	900	250	SRTB2120MUO	
	900	300	SRTB2120NUO	
	1000	250	SRTB2130MW0	
	1000	300	SRTB2130NW0	

### Wooden intermediate shelf with backedge - for insertion

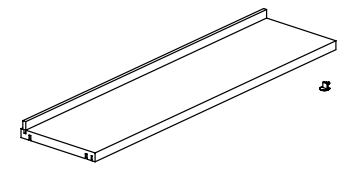
Melamine coated/veneer. Shelves are not fixed and are moveable. Pins incl. When turned, the shelf can be used as a sloping shelf by using the existing pins.	Module mm	Shelf depth mm	Item no.	C
	500	250	SRTB2121MRO	
	500	300	SRTB2121NRO	
	750	250	SRTB2121MSO	
	750	300	SRTB2121NSO	
	900	250	SRTB2121MUO	
	900	300	SRTB2121NUO	
	1000	250	SRTB2131MW0	
	1000	300	SRTB2131NW0	

# SHELVES

## WOODEN SHELVES

Bay H1096 must have 2/4 shelves (top and bottom) and bays H1512 or higher must have 3/6 shelves (top, intermediate and bottom) screwed into the panels for stability. The remaining shelves can be inserted via pins. 500, 750 and 900 mm wooden shelves are made of particle board, 1000 mm shelves are made of blockboard (to prevent shelf from sagging).

### Sloping wooden intermediate shelf with front stop - for insertion

Melamine coated/veneer. Shelves are not fixed and are moveable. Pins incl.

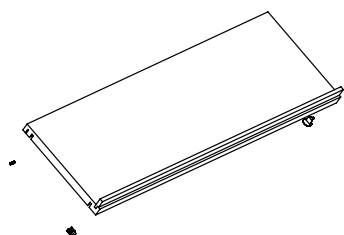

Module mm	Shelf depth mm	Item no.	C
500	250	SRTB2621MRO	
500	300	SRTB2621NRO	
750	250	SRTB2621MSO	
750	300	SRTB2621NSO	
900	250	SRTB2621MUO	
900	300	SRTB2621NUO	
1000	250	SRTB2631MWO	
1000	300	SRTB2631NWO	

### Wooden intermediate and bottom shelf with backedge - for screw fixation

Melamine coated/veneer. To be screwed into panels. Screws incl.

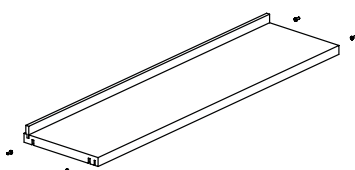

Module mm	Shelf depth mm	Item no.	C
500	250	SRTB2921MRO	
500	300	SRTB2921NRO	
750	250	SRTB2921MSO	
750	300	SRTB2921NSO	
900	250	SRTB2921MUO	
900	300	SRTB2921NUO	
1000	250	SRTB2931MWO	
1000	300	SRTB2931NWO	

### Wooden bottom shelf with plinth - for screw fixation

Melamine coated/veneer. To be screwed into panels. Screws incl.

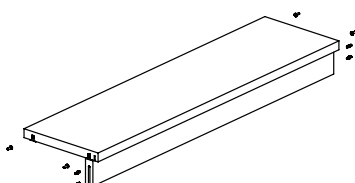

Module mm	Shelf depth mm	Item no.	C
500	250	SRTB2420MRO	
500	300	SRTB2420NRO	
750	250	SRTB2420MSO	
750	300	SRTB2420NSO	
900	250	SRTB2420MUO	
900	300	SRTB2420NUO	
1000	250	SRTB2430MWO	
1000	300	SRTB2430NWO	

### Wooden bottom shelf with plinth and backedge - for screw fixation

Melamine coated/veneer. To be screwed into panels. Screws incl.

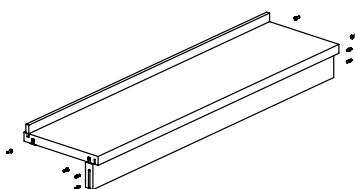

Module mm	Shelf depth mm	Item no.	C
500	250	SRTB2421MRO	
500	300	SRTB2421NRO	
750	250	SRTB2421MSO	
750	300	SRTB2421NSO	
900	250	SRTB2421MUO	
900	300	SRTB2421NUO	
1000	250	SRTB2431MWO	
1000	300	SRTB2431NWO	

# SHELVES

## WOODEN COVER TOP SHELVES

This cover top shelf can be used individually as top shelf or be placed directly onto a traditional wooden or steel top shelf to create a design variation. It can also be used as a work surface especially on low bays (1100 mm). It is available as single, starter, middle and end shelf. It is also available as a continuous cover top shelf for 2-3 bays upon request (max. length 2600 mm). Standard top shelf with sign profile and hanging book supports can be used in combination with the cover top shelf.

### Wooden cover top shelf - single

Melamine coated/veneer.



Module mm	Shelf depth mm	Item no. Single-sided	Item no. Double-sided
500	250	SRTB8750MRO	SRTB8751MRO
500	300	SRTB8750NRO	SRTB8751NRO
750	250	SRTB8750MSO	SRTB8751MSO
750	300	SRTB8750NSO	SRTB8751NSO
900	250	SRTB8750MUO	SRTB8751MUO
900	300	SRTB8750NUO	SRTB8751NUO
1000	250	SRTB8750MWO	SRTB8751MWO
1000	300	SRTB8750NWO	SRTB8751NWO

### Wooden cover top shelf - starter

Melamine coated/veneer.

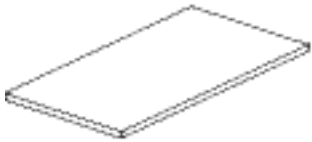

Module mm	Depth mm	Item no. Single-sided	Item no. Double-sided
500	250	SRTB8750MRL	SRTB8751MRL
500	300	SRTB8750NRL	SRTB8751NRL
750	250	SRTB8750MSL	SRTB8751MSL
750	300	SRTB8750NSL	SRTB8751NSL
900	250	SRTB8750MUL	SRTB8751MUL
900	300	SRTB8750NUL	SRTB8751NUL
1000	250	SRTB8750MWL	SRTB8751MWL
1000	300	SRTB8750NWL	SRTB8751NWL

### Wooden cover top shelf - middle

Melamine coated/veneer.

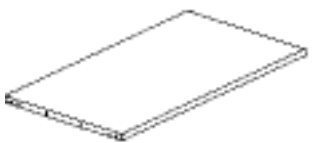

Module mm	Shelf depth mm	Item no. Single-sided	Item no. Double-sided
500	250	SRTB8750MRM	SRTB8751MRM
500	300	SRTB8750NRM	SRTB8751NRM
750	250	SRTB8750MSM	SRTB8751MSM
750	300	SRTB8750NSM	SRTB8751NSM
900	250	SRTB8750MUM	SRTB8751MUM
900	300	SRTB8750NUM	SRTB8751NUM
1000	250	SRTB8750MWM	SRTB8751MWM
1000	300	SRTB8750NWM	SRTB8751NWM

# SHELVES

## WOODEN COVER TOP SHELVES

This cover top shelf can be used individually as top shelf or be placed directly onto a traditional wooden or steel top shelf to create a design variation. It can also be used as a work surface especially on low bays (1100 mm). It is available as single, starter, middle and end shelf. It is also available as a continuous cover top shelf for 2-3 bays upon request (max. length 2600 mm). Standard top shelf with sign profile and hanging book supports can be used in combination with the cover top shelf.

### Wooden cover top shelf - end

Melamine coated/veneer.



Module mm	Shelf depth mm	Item no. Single-sided	■	Item no. Double-sided	■
500	250	SRTB8750MRR		SRTB8751MRR	
500	300	SRTB8750NRR		SRTB8751NRR	
750	250	SRTB8750MSR		SRTB8751MSR	
750	300	SRTB8750NSR		SRTB8751NSR	
900	250	SRTB8750MUR		SRTB8751MUR	
900	300	SRTB8750NUR		SRTB8751NUR	
1000	250	SRTB8750MWR		SRTB8751MWR	
1000	300	SRTB8750NWR		SRTB8751NWR	

# FUNCTIONS

## BOOK SUPPORTS

### HANGING

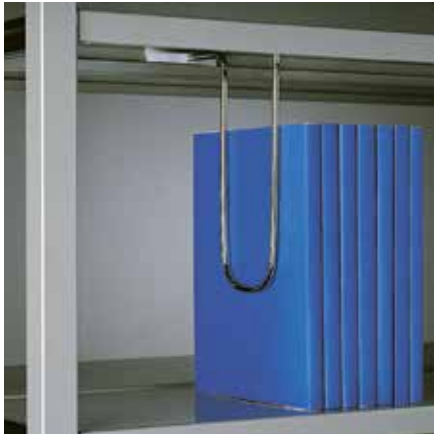

SXXB8002...

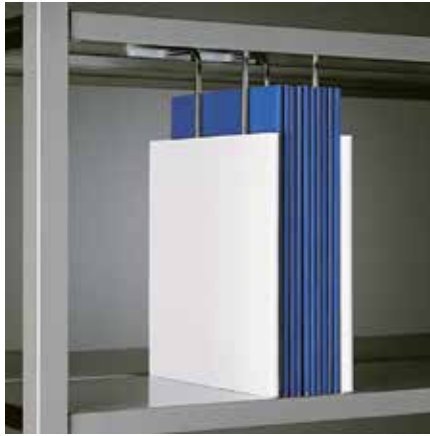

SXXB8005...

### ANGLED



SXXB8021...



SXXB8023...



SXXB8024...

# FUNCTIONS

## BOOK SUPPORTS - HANGING

---

### Hanging book supports - for steel shelves - model BS22

Chromed round steel with unbreakable plastic sliders. For insertion in steel shelves. Easy adjustable.

Height mm	Shelf depth mm
220	250
220	300

Item no.



SXXB8002M00  
SXXB8002N00



---

### Hanging book supports - for steel shelves - model BS28

Chromed round steel with unbreakable plastic sliders. For insertion in steel shelves. Easy adjustable. For shelves with high distance between shelves.

Height mm	Shelf depth mm
280	250
280	300

Item no.



SXXB8002M28  
SXXB8002N28



---

### Divider for hanging book supports - for steel shelves - model TS

D240 mm. White plastic. For sliding onto hanging book support model BS22 and BS28. The divider rests upon the shelf. Is ideal for loose-leaf material, brochures, music books etc.

Height mm	Shelf depth mm
250	250 & 300

Item no.

SXXB8005M00

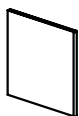

# FUNCTIONS

## BOOK SUPPORTS - ANGLED

---

### Angled book support - model WB1 & 2 - for steel and wooden shelves

W120 x D150 mm. Lacquered steel.

Height  
mm

Item no.



175  
240

SXXB8021010  
SXXB8021020

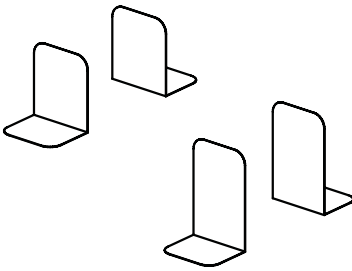

---

### Angled book support - model WBG - for steel shelves

W150 x D150 mm. Lacquered steel.  
Attached onto front of shelf. Selfadhesive plastic label holder can be attached to front of book support, to be ordered separately.

Height  
mm

Books left/right of  
book support

With/without  
letter tag

Item no.



200  
200

Right  
Left

Without  
Without

SXXB802300R  
SXXB802300L

200  
200

Right  
Left

With  
With

SXXB802310R  
SXXB802310L

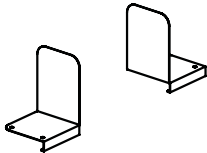

---

### Universal angled book support - model WBU - for steel shelves

W175 x D182 mm. Lacquered steel.  
Can be used for both right and left stop.  
Attached onto front of shelf. Selfadhesive plastic label holder can be attached to front of book support, to be ordered separately.

Height  
mm

Item no.



175

SXXB8024000

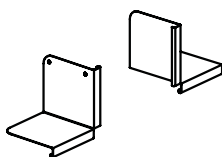



# FUNCTIONS

## ACCESSORIES FOR SHELVES AND SHELVING SYSTEMS

---

### Bracket for steel intermediate shelf with backedge - for creating sloping shelf

Chrome round steel. Used with shelf item no. SRTB2111 to create sloping shelf. The angle is adjustable, but 45° is recommended. Two brackets required per shelf.

Item no.

SRTB8010000

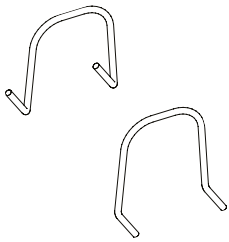

# FUNCTIONS

DISPLAY & STORAGE - FOR SHELVES



SXXB8025...



SXXB8026...



SXXB8027...



SXXB8313...

# FUNCTIONS

DISPLAY & STORAGE - FOR SHELVES



SRTB8315...



SXXB8311...



SXXB8505...



SXXB8500...



SXXB8321...

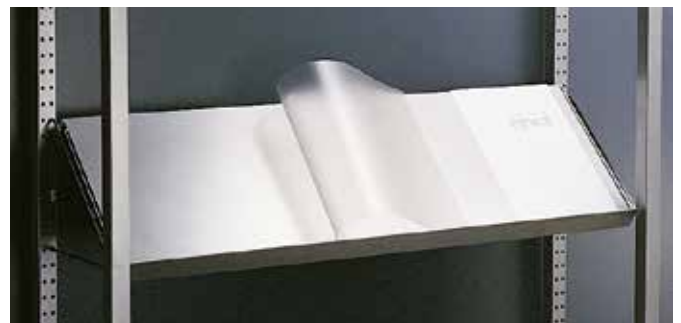

SXXB8322...

# FUNCTIONS

## DISPLAY & STORAGE - FOR SHELVES

Presentation and storage of magazines.

---

### Magazine display

H300 mm. Lacquered steel. With slanted back and additional side stop. A double front edge keeps this collector flush with the front edge of the shelf. With slip stop to prevent the display from slipping on steel shelves.

Size	Width mm
DIN A4	220
DIN A3	440

Item no.
SXXB8025A40
SXXB8025A30

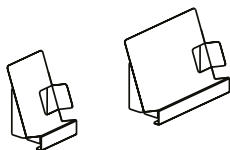

---

### Magazine divider

H300 x W95 x D240 mm. Lacquered steel. Single, slanted element connectable side by side via plug-in connections. For bay W700 mm, use 6 dividers  
For bay W900 mm, use 8 dividers  
For bay W1000 mm, use 9 dividers

Size
DIN A4

Item no.
SXXB8026000

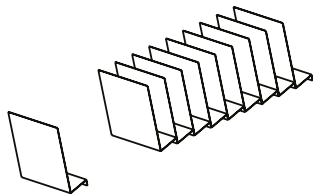

---

### U-storage

H250 x W145 x D220 mm. Lacquered steel. Multi-functional storage use.

Item no.
SXXB8027000

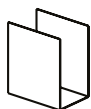

---

### Periodical collector

H325 x W80 x D230 mm. Light grey plastic. Multi-functional storage use. With front-edge for easy guidance along shelf.

Item no.
SXXB8313000



# FUNCTIONS

## DISPLAY & STORAGE - FOR SHELVES

Presentation and storage of CD's as well as accessories for sloping shelves.

---

### Slanted CD tray

H120 x W150 x D220 mm. Lacquered steel. With anti-slipping feet. Rubber mat to be ordered separately.

Approx. capacity

Item no.

20 CD's  
Rubber mat

SXXB8505000  
SXXB8506000



---

### CD racks

H40 x W311/464 x D262 mm. Chromed steel. Can be used on both wooden and steel shelves D250 mm.

Approx. capacity

Item no.

28 CD's  
42 CD's

SXXB8500002  
SXXB8500003

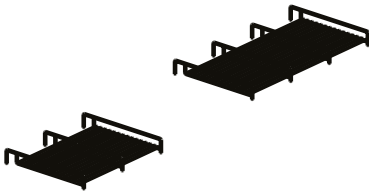

---

### Plastic insert

H60 x D296 mm. Transparent acrylic glass. For placement on book stop of sloping shelves D300 mm in order to extend height of book stop to H60 mm. Enables storage of newspaper/magazine stacks and thick books.

Module  
mm

Item no.

500

SXXB8321NR0

750

SXXB8321NS0

900

SXXB8321NU0

1000

SXXB8321NW0

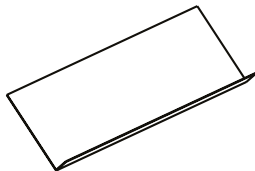

---

### Transparent foil

D295 x W1000 mm. Transparent plastic. For placement on sloping shelves D300 mm with book stop. Cut into shorter lengths for other widths.

Item no.

SXXB83220W0

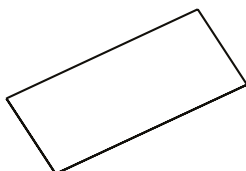

# FUNCTIONS

## DISPLAY AND STORAGE - FOR SHELVES

Create storage space for magazines on horizontal shelves. Add a flap or box to existing shelves to present current edition as well as systemize and store previous editions of magazines.

### Steel magazine flap

H340 mm (without shelf). Lacquered steel. Min. height between shelves must be 327 mm. To be screwed into panels. Effective lever mechanism keeps the open flap up. Easily retrofitted for single- and double-sided shelves. Recommended to use with back panels. Ratio bays H2248 mm can be equipped with max. 6 flaps. With space for storage of magazines piled horizontally 160 mm.

Module mm	Width mm	Depth mm
500	461	250
500	461	300
750	711	250
750	711	300
900	861	250
900	861	300
1000	961	250
1000	961	300

Item no.
SRTB8315MRO
SRTB8315NRO
SRTB8315MSO
SRTB8315NSO
SRTB8315MUO
SRTB8315NUO
SRTB8315MWO
SRTB8315NWO

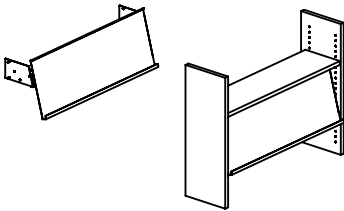

### Steel Querbox

H320 x D260 x W320 mm. Box and flap lacquered steel. Individual box with transparent antireflex foil. Recommended for use on D250 mm steel shelf with/without backedge and wooden shelf without backedge. Can be used on D300 mm shelves. With space for storage of magazines piled horizontally 140 mm.

Design	Back wall
-	Yes
-	No
With holes	Yes
With holes	No
With slots	Yes
With slots	No

Item no.
SXXB8311000

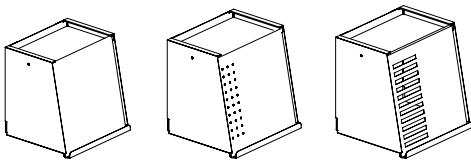

### Steel magazine box

H320 x D260 x W238 mm. Box and flap lacquered steel. Individual box. Recommended for use on D250 mm steel shelf with/without backedge and wooden shelf without backedge. Can be used on D300 mm shelves. Upright storage of magazines. With space for storage of magazines piled vertically 140 mm.

Item no.
SXXB8310000

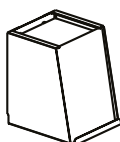

# FUNCTIONS

## DISPLAY AND STORAGE - FOR CROSSBAR

The Ratio system can be retrofitted with various display and storage functions. They can either be inserted on existing shelves or on crossbars, depending on function.

---

### Wooden Cube display box

H404 x W400 x D330 mm. Available in red, green or orange as standard. Other colours available on request. Individual box for display. Must be mounted on shelving using crossbar.

Item no.

SXXB8400000

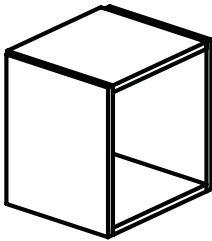

---

### Steel crossbar for Cube display box

To be used for mounting Cube display box on Ratio shelving. The box must be fixed on steel crossbar on both the top and the bottom, so a minimum of two steelbars must be ordered for one box.

Module  
mm

500

750

900

1000

Item no.

SRTB84010R0

SRTB84010S0

SRTB84010U0

SRTB84010W0



# FUNCTIONS

DISPLAY & STORAGE - FOR FUNCTIONAL END PANELS



SXXB8260... & SXXB8262...



SXXB8261...



# FUNCTIONS

## STORAGE AND DISPLAY - FOR FUNCTIONAL END PANELS

Below are accessories for functional end panels.

---

### Wooden sign for functional end panel

H368 x W489/589 mm. Melamine coated/veneer. Labelling upon request.

Width mm	Depth mm	Bay	Item no.	■
489	250	Double-sided	SXXB82600M0	
589	300	Double-sided	SXXB82600N0	

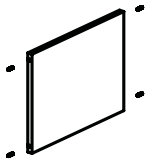

---

### Steel display shelf for functional end panel

H280 x W489/589 mm. Lacquered steel.

Width mm	Depth mm	Bay	Item no.	●
489	250	Double-sided	SXXB82610M0	
589	300	Double-sided	SXXB82610N0	

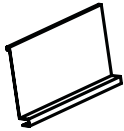

---

### Wooden folder rack for functional end panel

H140 x W489/589 mm. Melamine coated/veneer. Front and three adjustable dividers in acrylic glass.

Width mm	Depth mm	Bay	Item no.	■
489	250	Double-sided	SXXB82620M0	
589	300	Double-sided	SXXB82620N0	

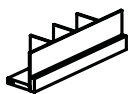

# FUNCTIONS

## BROWSERS



SRTB8620...



SRTB8600...



SRTB8602...



SRTB8510...

# FUNCTIONS

## BROWSERS

For safety reasons only load the the browsers with pull-out function with a maximum of 15 kg. Only install a maximum of 3 pull-out browsers on single-sided shelving and 1 pull-out browsers on each side of a double-sided shelving. Shelving with castors should not have pull-out browsers installed. The lowest browser must be at least 50 cm above the floor to prevent being used as a step.

### AV steel browser - for shelf

H100 mm. Lacquered steel browser and dividers with black flocked steel rods. Rubber mat and 2-5 moveable dividers incl. To be fastened onto existing 250 or 300 mm deep steel or wooden shelf without backedge.

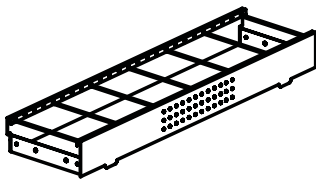

Width mm	Depth mm	Approx. capacity	Item no.
500	250	60 CD's/DVD's	SXXB8620MR1
500	300	72 CD's/DVD's	SXXB8620NR1
750	250	80 CD's/DVD's	SXXB8620MS1
750	300	96 CD's/DVD's	SXXB8620NS1
900	250	100 CD's/DVD's	SXXB8620MU1
900	300	120 CD's/DVD's	SXXB8620NU1
1000	250	120 CD's/DVD's	SXXB8620MW1
1000	300	144 CD's/DVD's	SXXB8620NW1

### AV steel browser - for panels

H100 mm. Lacquered steel browser and dividers with black flocked steel rods. Rubber mat and 2-5 moveable dividers incl. To be mounted between panels.

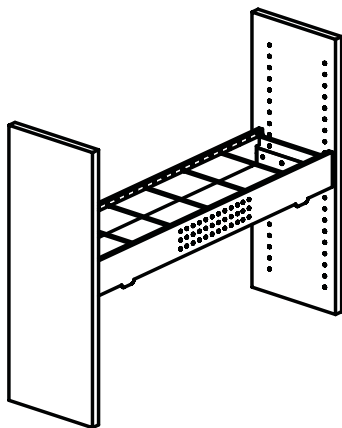

Width mm	Depth mm	Approx. capacity	Item no.
500	250	60 CD's/DVD's	SRTB8620MR2
500	300	72 CD's/DVD's	SRTB8620NR2
750	250	80 CD's/DVD's	SRTB8620MS2
750	300	96 CD's/DVD's	SRTB8620NS2
900	250	100 CD's/DVD's	SRTB8620MU2
900	300	120 CD's/DVD's	SRTB8620NU2
1000	250	120 CD's/DVD's	SRTB8620MW2
1000	300	144 CD's/DVD's	SRTB8620NW2

# FUNCTIONS

## BROWSERS

For safety reasons only load the the browsers with pull-out function with a maximum of 15 kg. Only install a maximum of 3 pull-out browsers on single-sided shelving and 1 pull-out browsers on each side of a double-sided shelving. Shelving with castors should not have pull-out browsers installed. The lowest browser must be at least 50 cm above the floor to prevent being used as a step.

### AV steel browser - with pull-out function - for panels

H100 mm. Lacquered steel browser and dividers with black flocked steel rods. Rubber mat and 2-5 moveable dividers incl. With handle for pullout function on telescopic rails.

Width mm	Depth mm	Approx. capacity	Item no.
500	250	60 CD's/DVD's	SRTB8620MR0
500	300	72 CD's/DVD's	SRTB8620NR0
750	250	80 CD's/DVD's	SRTB8620MS0
750	300	96 CD's/DVD's	SRTB8620NS0
900	250	100 CD's/DVD's	SRTB8620MU0
900	300	120 CD's/DVD's	SRTB8620NU0
1000	250	120 CD's/DVD's	SRTB8620MW0
1000	300	144 CD's/DVD's	SRTB8620NW0

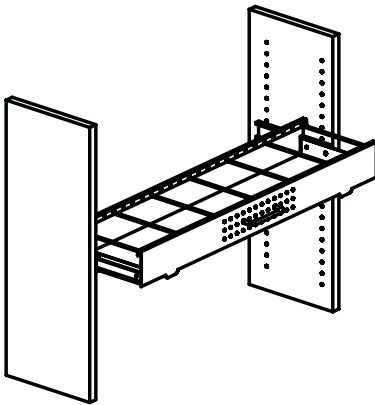

### AV steel browser - with pull-out and soft closing function - for panels

H100 mm. Lacquered steel browser and dividers with black flocked steel rods. Rubber mat and 2-5 moveable dividers incl. With handle for pullout function on telescopic rails.

Width mm	Depth mm	Approx. capacity	Item no.
500	250	60 CD's/DVD's	SRTB8620MR3
500	300	72 CD's/DVD's	SRTB8620NR3
750	250	80 CD's/DVD's	SRTB8620MS3
750	300	96 CD's/DVD's	SRTB8620NS3
900	250	100 CD's/DVD's	SRTB8620MU3
900	300	120 CD's/DVD's	SRTB8620NU3
1000	250	120 CD's/DVD's	SRTB8620MW3
1000	300	144 CD's/DVD's	SRTB8620NW3

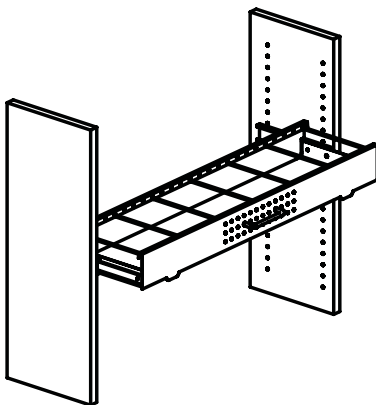

# FUNCTIONS

## BROWSERS

Shelving with castors should not have pull-out browsers installed. The lowest browser must be at least 50 cm above the floor to prevent being used as a step.

### AV browser - for panels

H100 x D376 mm. Browser and dividers lacquered steel, wooden sides melamine coated/veneer. Hanging kit, rubber mat, 2 stainless steel tubes and 4/5 dividers incl. Dividers are moveable. To be screwed into panels.

Module mm	Depth mm	Approx. capacity	Item no.
900	250	150 CD's/DVD's	SRTB8600MU0
900	300	150 CD's/DVD's	SRTB8600NU0
1000	250	180 CD's/DVD's	SRTB8600MW0
1000	300	180 CD's/DVD's	SRTB8600NW0

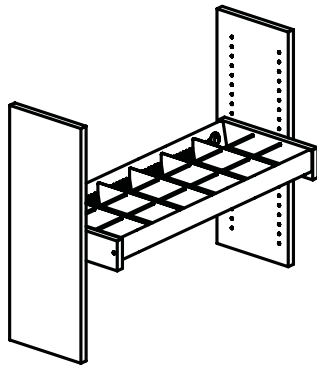

### Comic and map browser - for panels

H200 x D376 mm. Browser and dividers lacquered steel, wooden sides melamine coated/veneer. Hanging kit, rubber mat and 2-5 dividers incl. Dividers are moveable. To be screwed into panels.

Module mm	Depth mm	Dividers	Approx. capacity	Item no.
900	250	2	102 comics	SRTB8602MU0
900	250	4	135 maps	SRTB8602MU1
900	300	2	102 comics	SRTB8602NU0
900	300	4	135 maps	SRTB8602NU1
1000	250	3	136 comics	SRTB8602MW0
1000	250	5	162 maps	SRTB8602MW1
1000	300	3	136 comics	SRTB8602NW0
1000	300	5	162 maps	SRTB8602NW1

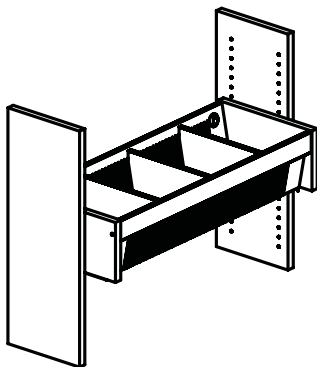

# FUNCTIONS

## BROWSERS

### Connectable steel AV steel browser - for panels

D110 mm, front edge H50 mm. Browser lacquered steel. Flexible solution for room-saving storage of CDs and DVDs. The browser can be placed single, double or triple (the third stair will protrude in front of the shelf). Hanging kit incl. Rubber mat to be ordered separately.

Module mm	Depth mm	Approx. capacity	Item no.
500	250	xx CD's/DVD's	SRTB8510MRO
750	250	xx CD's/DVD's	SRTB8510MSO
900	250	60 CD's/DVD's	SRTB8510MUO
1000	250	80 CD's/DVD's	SRTB8510MW0

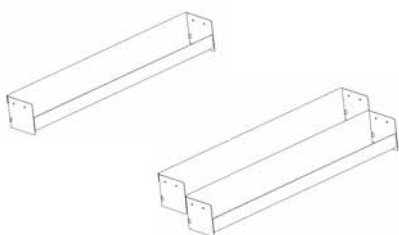

### Divider for AV steel browsers

Additional lacquered steel divider with flocked steel rod.

Depth mm	Item no.
250	SXXB8621M00
300	SXXB8621N00

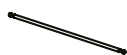

### Back rest for AV steel browsers

H50 mm. A laquered steel back rest that clips onto back of browser to increase resting height for larger medias.

Module mm	Item no.
500	SXXB86240R0
750	SXXB86240S0
900	SXXB86240U0
1000	SXXB86240W0

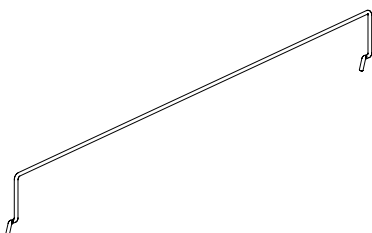

# FUNCTIONS

## BROWSERS

---

### Divider for AV browser

H75 mm. Lacquered steel.

Item no.



SXXB8601000

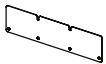

---

### Divider for comic book browser

H180 mm. Lacquered steel.

Item no.



SXXB8603000



---

### Rubber mat for connectable steel AV browser

Module mm	Depth mm
500	250
750	250
900	250
1000	250

Item no.

SRTB8511MRO  
SRTB8511MSO  
SRTB8511MUO  
SRTB8511MWO

# FUNCTIONS

## SIGNAGE



SXXB8040...

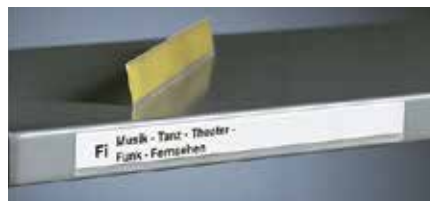

SXXB8044...



SXXB8045...



SXXB8019...

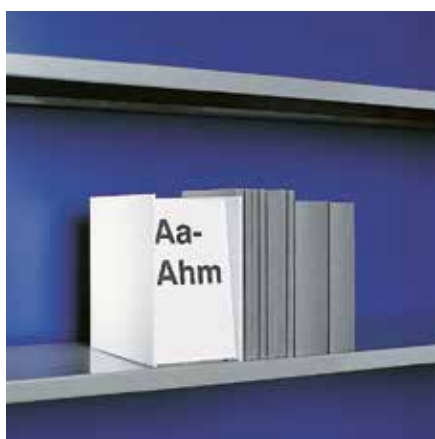

SXXB8060...

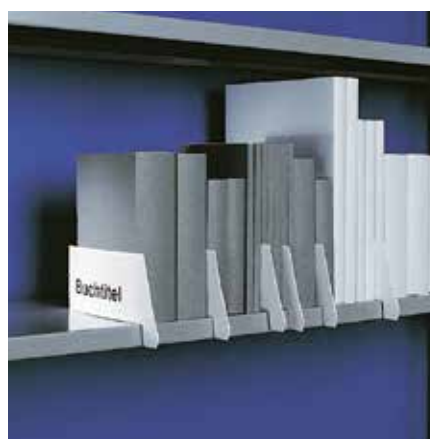

SXXB8061...



SUNB8101...



SRTB8103...



# FUNCTIONS

## SIGNAGE - SHELF LABELLING

---

### Clip plastic label holder

H21 mm. Transparent, antireflective plastic. Incl. white label. Clips into groove underneath steel or wooden shelf. Can glide along shelf.

Width  
mm

105

210

Item no.

SXXB8040200

SXXB8040000

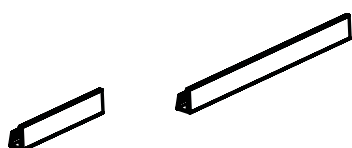

---

### Selfadhesive plastic label holder

H20 mm. Transparent, antireflective plastic. Incl. white label. For later attachment to angled book support, model WBU.

Width  
mm

147

200

Item no.

SXXB8044201

SXXB8044200



---

### Magnetic plastic label holder

H20 mm. Transparent, antireflective plastic. Incl. white label. Attach to steel shelves with smooth edge.

Width  
mm

210

Item no.

SXXB8045000

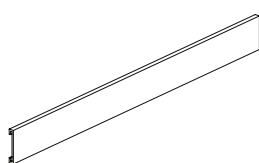

---

### Steel label holder

H26 x W150 x D150 mm. Lacquered steel with transparent, antireflective plastic. Incl. white label. Universal use, simply place on shelf where needed.

Item no.

SXXB8019000

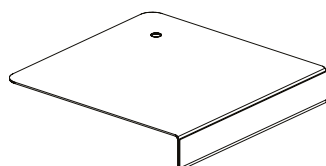

# FUNCTIONS

## SIGNAGE - SHELF LABELLING

---

### Labels - for all label holders and for angled book support (model WBG and WBU)

White sheet with 13 strips/labels.

Width  
mm

Item no.

104

SXXB8041200

209

SXXB8041000

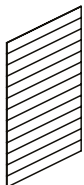

---

### Labelling cube

H200 x D200 mm. Acrylic glass.  
Inscription field with transparent cover  
on sloping front. Incl. white cardboard  
label. Universal use, place in between  
books on shelf where needed.

Width  
mm

Item no.

120

SXXB8060000

200

SXXB8060200

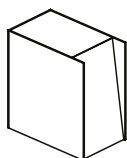

---

### Book substitute

H74 x W153 mm. White/blue/green/  
red plastic with transparent pocket for  
label. Incl. white label. Universal use,  
place on shelf where needed.

Width  
mm

Item no.

SXXB8061000

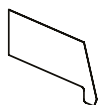

# FUNCTIONS

## SIGNAGE - STEEL SIGNS

### Steel top sign

Sign H150 mm. Holder H250 mm. Lacquered steel. 1/2 holders incl. Is screwed onto single and double-sided bays. Sign is pushed into holders. Labelling upon request.

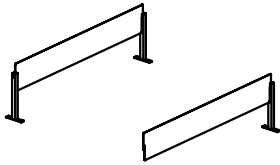

Width mm	Holders	Bay	Item no.
500	2	Starter	SRTB8101GR0
500	1	Add-on	SRTB8101AR0
750	2	Starter	SRTB8101GS0
750	1	Add-on	SRTB8101AS0
900	2	Starter	SRTB8101GU0
900	1	Add-on	SRTB8101AU0
1000	2	Starter	SRTB8101GW0
1000	1	Add-on	SRTB8101AW0

### Steel sign with plexiglas cover

H301 x W212 mm. White, lacquered steel. Installation material incl. For hanging on wooden panel. For format DIN upright A4.

Item no.

SRTB8080042



### Steel flag

Total H300 mm. Flag 80mm x W400 mm. Lacquered steel. Is screwed to inner shelf side. Is always mounted on the left and points to the right. Labelling upon request.

Item no.

SRTB8103000

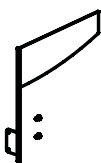

# FUNCTIONS

## DOORS



# FUNCTIONS

## DOORS

The Ratio system offers the possibility of closing off complete shelving bays or individual sections with either glass or wooden doors. To ensure stability, it is recommended that you only install the doors on bays equipped with a back panel. Existing bays with back panels can easily be retrofitted with glass or wooden doors.

### Glass doors - for Ratio-S

For single- or double-sided bays with back panels. Set consists of 2 lockable glass swing doors. All shelves fit in bays equipped with glass doors.

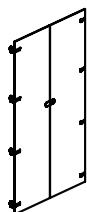

Width mm	Height mm	Door height mm	Item no.
900	1096	1007	SRTB8871GU0
900	1512	1423	SRTB8871CU0
900	1768	1679	SRTB8871AU0
900	2056	1967	SRTB8871DU0
900	2248	2159	SRTB8871EU0
1000	1096	1007	SRTB8871GW0
1000	1512	1423	SRTB8871CW0
1000	1768	1679	SRTB8871AW0
1000	2056	1967	SRTB8871DW0
1000	2248	2159	SRTB8871EW0

### Glass doors - for Ratio-B

For single- or double-sided bays with back panels. Set consists of 2 lockable glass swing doors. All shelves fit in bays equipped with glass doors.

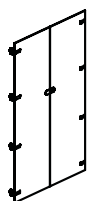

Width mm	Height mm	Door height mm	Item no.
900	1096	879	SRTB8872GU0
900	1512	1295	SRTB8872CU0
900	1768	1551	SRTB8872AU0
900	2056	1839	SRTB8872DU0
1000	1096	879	SRTB8872GW0
1000	1512	1295	SRTB8872CW0
1000	1768	1551	SRTB8872AW0
1000	2056	1839	SRTB8872DW0

### Wooden doors - for Ratio-S

Melamine coated/veneer. For single- or double-sided bays with back panels. Set consists of 2 lockable wooden swing doors. All shelves fit in bays equipped with wooden doors.

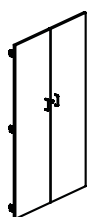

Width mm	Height mm	Door height mm	Item no.
900	1096	1016	SRTB8862GU0
900	1512	1432	SRTB8862CU0
900	1768	1688	SRTB8862AU0
900	2056	1976	SRTB8862DU0
900	2248	2168	SRTB8862EU0
1000	1096	1016	SRTB8862GW0
1000	1512	1432	SRTB8862CW0
1000	1768	1688	SRTB8862AW0
1000	2056	1976	SRTB8862DW0
1000	2248	2168	SRTB8862EW0

### Wooden doors - for Ratio-B

Melamine coated/veneer. For single- or double-sided bays with back panels. Set consists of 2 lockable wooden swing doors. All shelves fit in bays equipped with wooden doors.

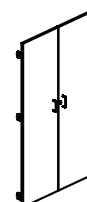

Width mm	Height mm	Door height mm	Item no.
900	1096	888	SRTB8865GU0
900	1512	1304	SRTB8865CU0
900	1768	1560	SRTB8865AU0
900	2056	1848	SRTB8865DU0
1000	1096	888	SRTB8865GW0
1000	1512	1304	SRTB8865CW0
1000	1768	1560	SRTB8865AW0
1000	2056	1848	SRTB8865DW0

# LOCATIONS

WE ARE LIBRARY PEOPLE®



## DENMARK

Lammhults Biblioteksdesign A/S  
Dalbækvej 1  
6670 Holsted

bci@bci.dk  
www.bci.dk

## FRANCE

BC Intérieur Sarl  
8, Allée Lorentz  
77420 Champs sur Marne

bci@bcinterieur.com  
www.bcinterieur.fr

## BELGIUM

SBNL - Schulz Benelux BVBA  
Appelweg 94 C  
3221 Holsbeek

info@sbnl.be  
www.sbnl.be

## SWEDEN

Lammhults Biblioteksdesign AB  
Odlarevägen 16  
226 60 Lund

eurobib@eurobib.se  
www.eurobib.se

## GERMANY

Schulz Speyer Bibliothekstechnik AG  
Friedrich-Ebert-Straße 2a  
67346 Speyer

sales@schulzspeyer.de  
www.schulzspeyer.de

## UNITED KINGDOM

thedesignconcept Ltd.  
The Old Bakery,  
10 Greenless Road  
Cambuslang Belgrave Street  
Glasgow G72 8JJ

info@thedesignconcept.co.uk  
www.thedesignconcept.co.uk

## NORWAY

BS Eurobib AS  
Alf Bjerckes vei 20  
0582 Oslo

post@bseurobib.no  
www.bseurobib.no