



RONDEA-F



RONDEA-W

High transparency and visual lightness are characteristics of the shelving system

Rondea

With round tubes, a broad furnishing programs and two different design, the Rondea is both individual and adaptable.

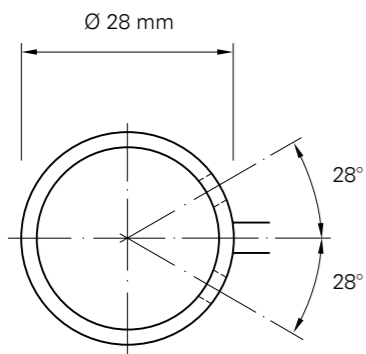

Scale 1 : 1



Integrated book end-stop





End panels from perforated sheet metal, presentation grids, end wall shelves, levelled shelves, lettering signs etc. are only a small extract from the possible design and function options which this system opens up to the user.

Our accessory catalogue for Shulz Shelving Systems provides more information about additional furnishing options for the Rondea shelving system.

End wall furnishing



Perforated side panels with round holes RG 5/25



RONDEA

Transparent Elegance

High transparency and visual lightness are the characteristics of the shelving and furniture programme RONDEA.



Two different design variants take account of the individual demands for the furnishing of public libraries. Smoothly designed, without irritating edges and corners, the RONDEA-F variant can be integrated randomly into existing structures through its neutral appearance. Those who intentionally want to bring some fresh air with their new furniture will spontaneously like the dynamic variant RONDEA-W.

Our furniture programmes are demonstrating their flexibility during everyday use. The systems are widespread; all areas of use in a library can be well covered. The abundant range of accessories from our SchulzShelvingSystem Accessory Catalogue makes our programmes adaptable and allows for an uncompromising orientation towards all possible customer requests.

Function as well as quality, Schulz Shelving Systems have been designed for long-term use and for the high strains in library areas.

Best production standards, high resilience and highest quality levels – officially proven and confirmed - contribute significantly to the conservation of value of our furniture.

Colors and surfaces in accordance with the symbols on the Schulz ColorRange:

- Colors: **for lacquered metal or wood**
- Surfaces: **in wood or plastic**



Single-sided Bays

Single-sided starter bay RONDEA-F with frame traverse, without shelves

Lacquered metal, D 276 mm for shelf depth 250 mm = M

		Axle size 1000 mm	Axle size 900 mm	Axle size 750 mm	Axle size 500 mm
H 1100 mm	Item no.	B 1100 GWM RO	B 1100 GUM RO	B 1100 GSM RO	B 1100 GRM RO
H 1500 mm	Item no.	B 1100 CWM RO	B 1100 CUM RO	B 1100 CSM RO	B 1100 CRM RO
H 1750 mm	Item no.	B 1100 AWM RO	B 1100 AUM RO	B 1100 ASM RO	B 1100 ARM RO
H 2050 mm	Item no.	B 1100 DWM RO	B 1100 DUM RO	B 1100 DSM RO	B 1100 DRM RO

For shelf depth 300 mm = N (D 276 mm) the M in the item no. is replaced by an N.

Single-sided add-on bay UNIFLEX-S with frame traverse, without shelves

Lacquered metal, D 276 mm for shelf depth 250 mm = M

		Axle size 1000 mm	Axle size 900 mm	Axle size 750 mm	Axle size 500 mm
H 1100 mm	Item no.	B 1200 GWM RO	B 1200 GUM RO	B 1200 GSM RO	B 1200 GRM RO
H 1500 mm	Item no.	B 1200 CWM RO	B 1200 CUM RO	B 1200 CSM RO	B 1200 CRM RO
H 1750 mm	Item no.	B 1200 AWM RO	B 1200 AUM RO	B 1200 ASM RO	B 1200 ARM RO
H 2050 mm	Item no.	B 1200 DWM RO	B 1200 DUM RO	B 1200 DSM RO	B 1200 DRM RO

For shelf depth 300 mm = N (D 276 mm) the M in the item no. is replaced by an N.

Double-sided Bays

Double-sided starter bay RONDEA-F with frame traverse, without shelves

Lacquered metal, D 524 mm for shelf depth 250 mm = M

		Axle size 1000 mm	Axle size 900 mm	Axle size 750 mm	Axle size 500 mm
H 1100 mm	Item no.	B 1300 GWM RO	B 1300 GUM RO	B 1300 GSM RO	B 1300 GRM RO
H 1500 mm	Item no.	B 1300 CWM RO	B 1300 CUM RO	B 1300 CSM RO	B 1300 CRM RO
H 1750 mm	Item no.	B 1300 AWM RO	B 1300 AUM RO	B 1300 ASM RO	B 1300 ARM RO
H 2050 mm	Item no.	B 1300 DWM RO	B 1300 DUM RO	B 1300 DSM RO	B 1300 DRM RO

For shelf depth 300 mm = N (D 624 mm) the M in the item no. is replaced by an N.

Double-sided add-on bay RONDEA-F with frame traverse, without shelves

Lacquered metal, D 524 mm for shelf depth 250 mm = M

		Axle size 1000 mm	Axle size 900 mm	Axle size 750 mm	Axle size 500 mm
H 1100 mm	Item no.	B 1400 GWM RO	B 1400 GUM RO	B 1400 GSM RO	B 1400 GRM RO
H 1500 mm	Item no.	B 1400 CWM RO	B 1400 CUM RO	B 1400 CSM RO	B 1400 CRM RO
H 1750 mm	Item no.	B 1400 AWM RO	B 1400 AUM RO	B 1400 ASM RO	B 1400 ARM RO
H 2050 mm	Item no.	B 1400 DWM RO	B 1400 DUM RO	B 1400 DSM RO	B 1400 DRM RO

For shelf depth 300 mm = N (D 624 mm) the M in the item no. is replaced by an N.

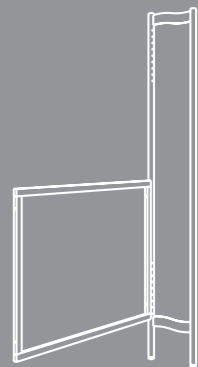
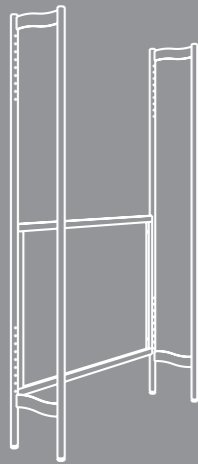

Single-sided Bays

Single-sided starter bay RONDEA-W with frame traverse, without shelves

Lacquered metal, D 276 mm for shelf depth 250 mm = M

		Axle size 1000 mm	Axle size 900 mm	Axle size 750 mm	Axle size 500 mm
H 1100 mm	Item no.	B 1101 GWM RO	B 1101 GUM RO	B 1101 GSM RO	B 1101 GRM RO
H 1500 mm	Item no.	B 1101 CWM RO	B 1101 CUM RO	B 1101 CSM RO	B 1101 CRM RO
H 1750 mm	Item no.	B 1101 AWM RO	B 1101 AUM RO	B 1101 ASM RO	B 1101 ARM RO
H 2050 mm	Item no.	B 1101 DWM RO	B 1101 DUM RO	B 1101 DSM RO	B 1101 DRM RO

For shelf depth 300 mm = N (D 276 mm) the M in the item no. is replaced by an N.

Single-sided add-on bay RONDEA-W with frame traverse, without shelves

Lacquered metal, D 276 mm for shelf depth 250 mm = M

		Axle size 1000 mm	Axle size 900 mm	Axle size 750 mm	Axle size 500 mm
H 1100 mm	Item no.	B 1201 GWM RO	B 1201 GUM RO	B 1201 GSM RO	B 1201 GRM RO
H 1500 mm	Item no.	B 1201 CWM RO	B 1201 CUM RO	B 1201 CSM RO	B 1201 CRM RO
H 1750 mm	Item no.	B 1201 AWM RO	B 1201 AUM RO	B 1201 ASM RO	B 1201 ARM RO
H 2050 mm	Item no.	B 1201 DWM RO	B 1201 DUM RO	B 1201 DSM RO	B 1201 DRM RO

For board depth 300 mm = N (D 276 mm) the M in the item no. is replaced by an N.

Double-sided Bays

Double-sided starter bay RONDEA-W with frame traverse, without shelves

Lacquered metal, D 524 mm for shelf depth 250 mm = M

		Axle size 1000 mm	Axle size 900 mm	Axle size 750 mm	Axle size 500 mm
H 1100 mm	Item no.	B 1301 GWM RO	B 1301 GUM RO	B 1301 GSM RO	B 1301 GRM RO
H 1500 mm	Item no.	B 1301 CWM RO	B 1301 CUM RO	B 1301 CSM RO	B 1301 CRM RO
H 1750 mm	Item no.	B 1301 AWM RO	B 1301 AUM RO	B 1301 ASM RO	B 1301 ARM RO
H 2050 mm	Item no.	B 1301 DWM RO	B 1301 DUM RO	B 1301 DSM RO	B 1301 DRM RO

For shelf depth 300 mm = N (D 624 mm) the M in the item no. is replaced by an N.

Double-sided add-on bay RONDEA-W with frame traverse, without shelves

Lacquered metal, D 524 mm for shelf depth 250 mm = M

		Axle size 1000 mm	Axle size 900 mm	Axle size 750 mm	Axle size 500 mm
H 1100 mm	Item no.	B 1401 GWM RO	B 1401 GUM RO	B 1401 GSM RO	B 1401 GRM RO
H 1500 mm	Item no.	B 1401 CWM RO	B 1401 CUM RO	B 1401 CSM RO	B 1401 CRM RO
H 1750 mm	Item no.	B 1401 AWM RO	B 1401 AUM RO	B 1401 ASM RO	B 1401 ARM RO
H 2050 mm	Item no.	B 1401 DWM RO	B 1401 DUM RO	B 1401 DSM RO	B 1401 DRM RO

For shelf depth 300 mm = N (D 624 mm) the M in the item no. is replaced by an N.

Add-On Front-Side Bays

Add-on front-side bay without shelves

As finish on front sides of double-sided bays.

With a shelf depth of 250 mm; for equipping with metal or wooden shelf shelves.
Axle size 500 mm; lacquered metal, incl. fastening material.
W 524 mm, D 276 mm

H 1100 mm	Item no.	B 1500 GRM RO	RONDEA-F
H 1500 mm	Item no.	B 1500 CRM RO	RONDEA-F
H 1750 mm	Item no.	B 1500 ARM RO	RONDEA-F
H 2050 mm	Item no.	B 1500 DRM RO	RONDEA-F

H 1100 mm	Item no.	B 1501 GRM RO	RONDEA-W
H 1500 mm	Item no.	B 1501 CRM RO	RONDEA-W
H 1750 mm	Item no.	B 1501 ARM RO	RONDEA-W
H 2050 mm	Item no.	B 1501 DRM RO	RONDEA-W



Equipment for Front-Sided Bays

Slanted shelves 60°

For the presentation of books, magazines etc.
For hanging on the front-sides of double-sided bays.
Lacquered metal; incl. hanging kit, W 469 mm

D 290 mm	Item no.	B 8222 0M0 RO
----------	-----------------	---------------

Front-side shelves

For hanging on front-sides of double-sided bays.
Lacquered metal; incl. hanging kit; W 469 mm, H 120 mm

D 250 mm	Item no.	B 8221 0M0 RO
----------	-----------------	---------------

Set of Castors for Double-Sided Bays

Set of castors for double-sided shelves

Can be easily retrofitted for double-sided bays with a shelf depth of 250 mm.
The special construction helps to avoid an uncomfortable offset in height with non-moving shelves; beyond that, the shelf also receives an additional horizontal stiffener.
Two set of wheels are required for basic shelves, one set for add-on shelves.
Angled sheet metal, lacquered; incl. fastening material and two wheels.
W 550 mm

Item no.	B 8013 0M0 RO	Standard type for PVC and carpet floors
Item no.	B 8013 0M1 RO	Variant type for wooden and stone floors



Metal Shelves

Metal shelf, including hanging kit

Lacquered metal

		Axle size 1000 mm	Axle size 900 mm	Axle size 750 mm	Axle size 500 mm
D 250 mm	Item no.	B 2110 MW0 RO	B 2110 MU0 RO	B 2110 MS0 RO	B 2110 MR0 RO
D 300 mm	Item no.	B 2110 NW0 RO	B 2110 NU0 RO	B 2110 NS0 RO	B 2110 NR0 RO

Metal shelf with book stop, including hanging kit

Lacquered metal

		Axle size 1000 mm	Axle size 900 mm	Axle size 750 mm	Axle size 500 mm
D 250 mm	Item no.	B 2111 MW0 RO	B 2111 MU0 RO	B 2111 MS0 RO	B 2111 MR0 RO
D 300 mm	Item no.	B 2111 NW0 RO	B 2111 NU0 RO	B 2111 NS0 RO	B 2111 NR0 RO

Metal magazine shelf, including hanging kit

With front edge; adjustable slant, depth 300 mm, Lacquered metal, for bays with a shelf depth 250 mm and 300 mm

Shelf depth		Axle size 1000 mm	Axle size 900 mm	Axle size 750 mm	Axle size 500 mm
D 250 mm	Item no.	B 2611 MW0 RO	B 2611 MU0 RO	B 2611 MS0 RO	B 2611 MR0 RO
D 300 mm	Item no.	B 2611 NW0 RO	B 2611 NU0 RO	B 2611 NS0 RO	B 2611 NR0 RO

Wooden Shelves

Wooden shelf, including hanging kit

veneered wood / plastic coated

		Axle size 1000 mm	Axle size 900 mm	Axle size 750 mm	Axle size 500 mm
D 250 mm	Item no.	B 2170 MW0 RO	B 2170 MU0 RO	B 2170 MS0 RO	B 2170 MR0 RO
D 300 mm	Item no.	B 2170 NW0 RO	B 2170 NU0 RO	B 2170 NS0 RO	B 2170 NR0 RO

Wooden shelf with book support guiding rail, incl. hanging kit

veneered wood / plastic coated
(designed for book support, model BSD 22/28)

		Axle size 1000 mm	Axle size 900 mm	Axle size 750 mm	Axle size 500 mm
D 250 mm	Item no.	B 2172 MW0 RO	B 2172 MU0 RO	B 2172 MS0 RO	B 2172 MR0 RO
D 300 mm	Item no.	B 2172 NW0 RO	B 2172 NU0 RO	B 2172 NS0 RO	B 2172 NR0 RO

Wooden shelf with book stop, including hanging kit

veneered wood / plastic coated

		Axle size 1000 mm	Axle size 900 mm	Axle size 750 mm	Axle size 500 mm
D 250 mm	Item no.	B 2171 MW0 RO	B 2171 MU0 RO	B 2171 MS0 RO	B 2171 MR0 RO
D 300 mm	Item no.	B 2171 NW0 RO	B 2171 NU0 RO	B 2171 NS0 RO	B 2171 NR0 RO

Wooden Shelves

Wooden shelf with book stop and book support guiding rail incl. hanging kit

veneered wood / plastic coated
(designed for book support, model BSD 22/28)

		Axle size 1000 mm	Axle size 900 mm	Axle size 750 mm	Axle size 500 mm
D 250 mm	Item no.	B 2173 MW0 RO	B 2173 MU0 RO	B 2173 MS0 RO	B 2173 MR0 RO
D 300 mm	Item no.	B 2173 NW0 RO	B 2173 NU0 RO	B 2173 NS0 RO	B 2173 NR0 RO

Wooden magazine shelf, including hanging kit and slanting braces

With front rebate, adjustable slant, depth 300 mm, veneered wood / plastic coated for bays with a shelf depth of 250 mm and 300 mm

Shelf depth		Axle size 1000 mm	Axle size 900 mm	Axle size 750 mm	Axle size 500 mm
D 250 mm	Item no.	B 2671 MW0 RO	B 2671 MU0 RO	B 2671 MS0 RO	B 2671 MR0 RO
D 300 mm	Item no.	B 2671 NW0 RO	B 2671 NU0 RO	B 2671 NS0 RO	B 2671 NR0 RO

Metal and Wooden Pull-Out Shelves

Pull-out shelf, flush mounted

Pull-out shelf on telescopic rails
For mounting under metal or wooden shelf from axle size 750 mm.
Pull-out is flush mounted with shelf when closed.
Pull-out depth 245 mm, width 600 mm, incl. fastening material and tilt stops

For supporting shelves

D 250 mm	Item no.	B 2000 M00 RO	Metal pull-out for metal shelves
D 300 mm	Item no.	B 2000 N00 RO	Metal pull-out for metal shelves

D 250 mm	Item no.	B 2002 M00 RO	Wooden pull-out for wooden shelves
D 300 mm	Item no.	B 2002 N00 RO	Wooden pull-out for wooden shelves

Pull-out shelf with overlap

Pull-out shelf on telescopic rails
For mounting under metal or wooden shelf from axle size 750 mm.
Pull-out is overlapping 50 mm over shelf when closed and can be better identified as pull-out shelf.
Pull-out depth 295 mm, width 600 mm, incl. fastening material and tilt stops

For supporting shelves

D 250 mm	Item no.	B 2001 M00 RO	Metal pull-out for metal shelves
D 300 mm	Item no.	B 2001 N00 RO	Metal pull-out for metal shelves

D 250 mm	Item no.	B 2003 M00 RO	Wooden pull-out for wooden shelves
D 300 mm	Item no.	B 2003 N00 RO	Wooden pull-out for wooden shelves

Wooden Shelves

Wooden shelf with integrated book end supports

veneered wood / plastic coated

1 2

D 250 mm	Item no.	Axle size 1000 mm	Axle size 900 mm	Axle size 750 mm	Axle size 500 mm
		B 2124 MW0 RO	B 2124 MU0 RO	B 2124 MS0 RO	B 2124 MR0 RO

Wooden shelf with book stop and integrated book end support

veneered wood / plastic coated

1 2

D 250 mm	Item no.	Axle size 1000 mm	Axle size 900 mm	Axle size 750 mm	Axle size 500 mm
		B 2125 MW0 RO	B 2125 MU0 RO	B 2125 MS0 RO	B 2125 MR0 RO

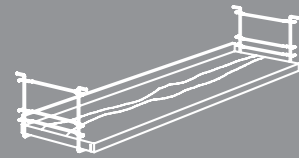
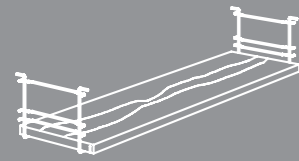

End Panels

Perforated sheet-metal end panels

(only available for variant RONDEA-F)

As front-side shelf finish for hanging in supporting frame with a shelf depth of 250 mm.

One side cover per bearing frame is required for single-sided bays, two side covers for double-sided bays.

Individual equipping with accessories for media presentation
See also Schulz Shelving Systems Accessory Catalogue

Lacquered metal

For bay height

H 1100 mm	Item no.	B 8810 GMR RO,	Round holes RG 5/25
H 1500 mm	Item no.	B 8810 CMR RO,	Round holes RG 5/25
H 1750 mm	Item no.	B 8810 AMR RO,	Round holes RG 5/25
H 2050 mm	Item no.	B 8810 DMR RO,	Round holes RG 5/25

For shelf depth 300 mm = N (W 330/630 mm) the M in the item no. is replaced by an N.

For bay height

H 1100 mm	Item no.	B 8810 GMQ RO,	Square holes QG 10/62,5
H 1500 mm	Item no.	B 8810 CMQ RO,	Square holes QG 10/62,5
H 1750 mm	Item no.	B 8810 AMQ RO,	Square holes QG 10/62,5
H 2050 mm	Item no.	B 8810 DMQ RO,	Square holes QG 10/62,5

For shelf depth 300 mm = N (W 330/630 mm) the M in the item no. is replaced by an N.

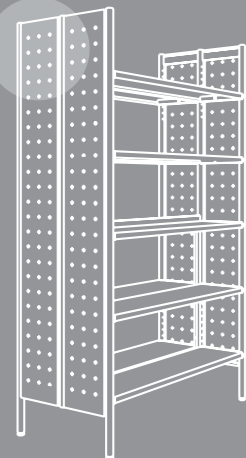
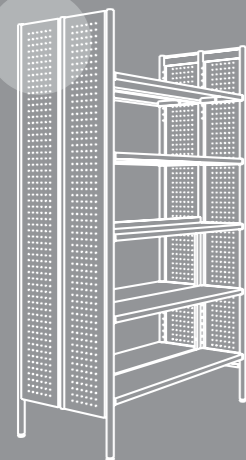

Display Stands

Display Stands

For individual equipping with accessories on both sides of shelf fronts such as hanging baskets, newspaper holders, book stands, front-side shelves, slanted shelves etc., see also Schulz Shelving Systems Accessory Catalogue; Lacquered metal; with 4 lockable wheels; W 568 mm, D 460 mm

H 1560 mm	Item no.	B 7010 CM0 RO	RONDEA-F
H 1810 mm	Item no.	B 7010 AM0 RO	RONDEA-F (see drawing)

H 1560 mm	Item no.	B 7011 CM0 RO	RONDEA-W
H 1810 mm	Item no.	B 7011 AM0 RO	RONDEA-W

Display stand for newspapers

Same description as display stand, but with newspaper holders, model ZHK equipped

H 1560 mm	Item no.	B 7010 CM1 RO	RONDEA-F with 8 newspaper holders
H 1810 mm	Item no.	B 7010 AM1 RO	RONDEA-F with 10 newspaper holders (see drawing)

H 1560 mm	Item no.	B 7011 CM1 RO	RONDEA-W with 8 newspaper holders
H 1810 mm	Item no.	B 7011 AM1 RO	RONDEA-W with 10 newspaper holders

Display with slanted shelves

Same description as display stand, but with slanted shelves 60°, model SAB 60 equipped

H 1560 mm	Item no.	B 7010 CM2 RO	RONDEA-F with 6 slanted shelves (see drawing)
H 1810 mm	Item no.	B 7010 AM2 RO	RONDEA-F with 8 slanted shelves

H 1560 mm	Item no.	B 7011 CM2 RO	RONDEA-W with 6 slanted shelves
H 1810 mm	Item no.	B 7011 AM2 RO	RONDEA-W with 8 slanted shelves

Display stand with slanted shelves and front side shelves

Same description as display stand, but with slanted shelves 60°, model SAB 60 and front-side shelf shelves, model STFB equipped

H 1560 mm	Item no.	B 7010 CM3 RO	RONDEA-F with 2 slanted boards & 4 front-side shelves (see drawing)
H 1810 mm	Item no.	B 7010 AM3 RO	RONDEA-F with 2 slanted boards and 6 front-side shelves

H 1560 mm	Item no.	B 7011 CM3 RO	RONDEA-W with 2 slanted boards & 4 front-side shelves
H 1810 mm	Item no.	B 7011 AM3 RO	RONDEA-W with 2 slanted boards and 6 front-side shelves



Presentation Grids

Labeling sign for presentation grids

Will be put on presentation grid as signpost and orientation guide; beech multiplex.
W 400 mm, H 284 mm

Item no. B 8202 000 RO

Presentation grid, straight

For fastening at front sides of double-sided bays with a shelf depth of 250 mm, as support system for presentation elements; see also Schulz Shelving Systems Accessory Catalogue.
Round steel, chromium-plated; incl. fastening material.
W 490 mm, H 1750 mm

Item no. B 8200 000 RO

Presentation grid, angled

Description as above, but with an expanded and angled presentation surface.
W 490 mm, D 522 mm, H 1750 mm

Item no. B 8201 000 RO

Description of System

Shelving system with framework construction for storing books, magazines and other printed media, as well as all other non-book media.

Bearing frames from round, diam. 28 mm, perforated interior shelf sides for tool-free adjustment of shelves with a 32 mm grid module. Depth connectors are available either as 4mm-thick metal plates or design pre-fab parts from flat metal.

Support feet equipped with leveling screws.

Longitudinal strut-bracing for shelves by diagonal traverses, individually screwed for each shelving section, Back panels upon request.

Mentioned axle sizes are nominal dimensions. A nominal axle size of 1000 mm is an actual axle size of 998 mm etc.

Shelves alternatively from wood or metal.

If desired, wooden shelves also available with chrome-plated, integrated book end supports.

Metal parts are lacquered according to DIN 50942 with a particularly resistant, environment friendly stove-enamel powder coating.

Most of the metal fittings are chrome-plated and therefore have long-term corrosion protection.

Wooden surfaces have an environment friendly lacquering or are plastic coated.

Cross-Section

Round tubes diam. 28 mm

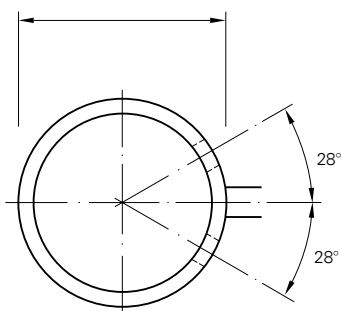

Scale 1:1



Tick- Tock- Tick- Tock- Tick- Tock...

Just like the mechanics of a clock where many adjusted parts match with each other, a well thought-out and balanced programme of accessories is vital for the functionality and quality of library furniture.

The following overview will introduce you to our shelving systems for scientific and public libraries.

These systems form the basis for using an extensive and future-oriented range of accessories which we have compiled in this catalogue.

Information on colours and surfaces is in accordance with the SchulzColorRange:

● Colours
for metal and wood lacquering

■ Surfaces
wooden or plastic

✱ Materials/cloth
for seating furniture



UNIFLEX (UN)

This classic shelving and organizing system is built as frame construction from square steel bars and stands for proven quality in a timeless design. UNIFLEX reveals its flexibility in daily use.

The extensive accessories and equipment programme enables an unconditional orientation towards all possible customer requests.



QUADRA (QU)

Our system QUADRA has an analogue construction, yet with square profiles, and has also been designed for long-term use in functionality and quality as well as for the very high demands and strains in libraries. You can choose between two different design options which will not only be functional but will set a trend in modern library furniture.



RONDEA (RO)

The elegant attitude of our shelving system RONDEA with round steel bars has been coined by reserve and transparency. The filigree construction emphasizes architecture and media. An extensive programme of accessories and two different design options make RONDEA quite adaptable.

Hanging Book Stops

Hanging book stop, Model BS 22

For insertion in metal shelves, easily adjustable, round steel, chromed, with unbreakable plastic sliders for an easy and quiet use.
H 220 mm

Fits all systems

For shelf depth	Item no.
250 mm	B 8002 M00 XX
300 mm	B 8002 N00 XX

Hanging book stop, Model BS 28

For insertion in metal shelves with high shelf distances, similar to model BS 22, also suitable for books with extremely large format or very small books through its extra size
H 280 mm

Fits all systems

For shelf depth	Item no.
250 mm	B 8002 M28 XX
300 mm	B 8002 N28 XX

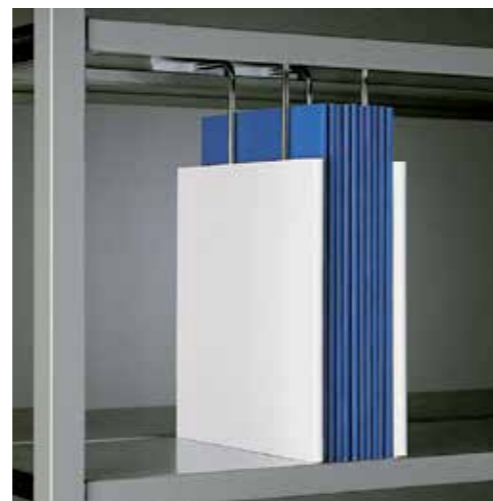

Divider, Model TS

For sliding upon hanging book stops, model BS 22 and BS 28. The divider lies directly upon the shelves through its own weight and is a valuable accessory part for loose-leaf collections, brochures, music books etc.
White plastic.
D 240 mm, H 250 mm

Fits all systems

For shelf depth	Item no.
250 mm and 300 mm	B 8005 M00 XX

Hanging book stop, Model HB 22

For insertion in Multiplex-wooden shelves with guiding grooves for book stops, easily side adjustable, chromed round steel.
H 220 mm

Item no.

UNIFLEX	B 8012 000 UN
QUADRA	B 8012 000 QU
RONDEA	B 8012 000 RO

Hanging book stop, Model BSD 22 BSD 28

For insertion in wooden shelves with guiding rail for book stops, easily adjustable, round steel, chromed.

Item no.	H 220 mm	H 280 mm
UNIFLEX	B 8003 000 UN	B 8003 028 UN
QUADRA	B 8003 000 QU	B 8003 028 QU
RONDEA	B 8003 000 RO	B 8003 028 RO



Book end stop, Model EP
For insertion in metal shelves with high shelf distances, similar to model BS 22, also suitable for books with extremely large format or very small books through its extra size
H 280 mm

For shelf depth 250 mm

Item no.

UNIFLEX	B 8006 000 UN
QUADRA	B 8006 000 QU
RONDEA	B 8006 000 RO

Book End Stops

Rod as book end stop, Model B 1

For insertion into the perforated holes of the bearing frame, thus variable in height; using two rods on top of each other will perfectly secure books against tipping (see picture), round steel, bright galvanized.

Item no.

1 each for	shelves depth 250 mm	shelves depth 300 mm
UNIFLEX	B 8001 M00 UN	B 8001 N00 UN
QUADRA	B 8001 M00 QU	B 8001 N00 QU
RONDEA	B 8001 M00 RO	B 8001 N00 RO

Book end stop brace, Model DR 2

For insertion into metal shelf boards, chromed round steel.
H 150 mm

Item no.

	shelves depth 250 mm	shelves depth 300 mm
UNIFLEX	B 8007 M00 UN	B 8007 N00 UN
QUADRA	B 8007 M00 QU	B 8007 N00 QU
RONDEA	B 8007 M00 RO	B 8007 N00 RO

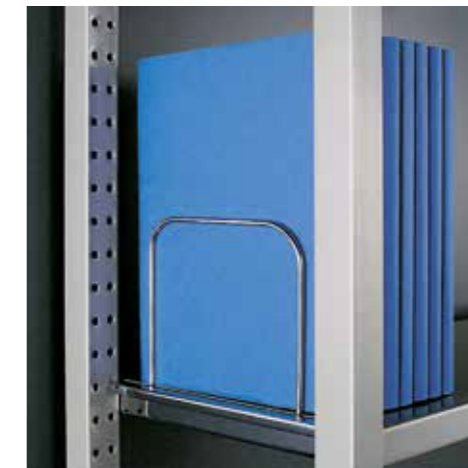

Angled Book Stops

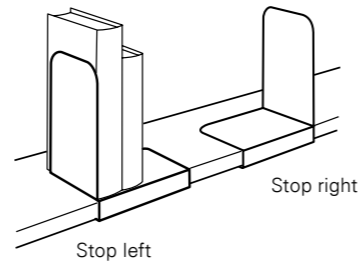

Angled book stop, Model WB
Suitable for all shelving systems, metal – lacquered white or black. W 120 mm, D 80 mm, H 130 mm

Fits all systems **Item no.**
B 8020 000 XX

Angled book stop, Model WB 1, WB 2
Suitable for all shelving systems, available in two heights, lacquered metal. ● W 120 mm, D 150 mm, H 175/240 mm

Fits all systems **Item no.**
Height 175 mm B 8021 010 XX
Height 240 mm B 8021 020 XX



Angled book stop, Model WBG
For metal shelves, stop right or left, with front edge and secured fastening for an optimum guiding and for attaching inscriptions. Lacquered metal. ● W 150 mm, D 150 mm, H 200 mm

Fits all systems	Item no.
Stop right	B 8023 00R XX
Stop left	B 8023 00L XX
With inscription, Stop right	B 8023 10R XX
With inscription, Stop left	B 8023 10L XX

Lettering tag, Model KA/S
For later attachment to angled book stops with front edge, transparent plastic, self-adhesive, incl. exchangeable white inscription card. W 147 mm, H 20 mm
Schulz Lettering Service upon request

Fits all systems **Item no.**
B 8044 201 XX

Blank lettering strips, white, sheet with 13 strips, W 209 mm (shorter sizes by cutting)
B 8041 000 XX



Universal angled book stop, Model WBU
For metal shelves, can be used left or right simply by turning, both sides with a front edge and secure fastening for optimum guiding, a broad grip edge prevents from unintentional movement of books onto the vertical support side, suitable for horizontal and vertical lettering. ● Lacquered metal. W 175 mm, D 182 mm, H 175 mm

Without lettering tag **Item no.**
Fits all systems B 8024 000 XX



Additional Furnishing for Shelves



Book stop, Model BA
For metal shelves, flexible use, can also be mounted as tilt securing for shelves with projection.
● Lacquered metal.
H 24 mm

	Item no.
Axle size 1000 mm	
UNIFLEX	B 8029 0W0 UN
QUADRA	B 8029 0W0 QU
Axle size 900 mm	
UNIFLEX	B 8029 0U0 UN
QUADRA	B 8029 0U0 QU
Axle size 750 mm	
UNIFLEX	B 8029 0S0 UN
QUADRA	B 8029 0S0 QU



Tilt securing, Model KIS
For extractable shelf respectively metal or wooden shelf with projection, prevents the forward tilt of the shelf in the bay; two tilt securings required per shelf, black plastic.

Item no.	1 each
UNIFLEX	B 8070 000 UN
QUADRA	B 8070 000 QU
RONDEA	B 8070 000 RO

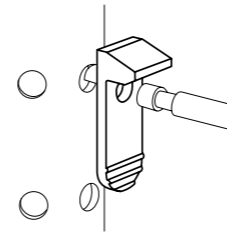

Shelf reinforcement, Model UZ
For metal shelves with extreme shelf, can be easily retrofitted, allows an additional weight of approx. 30 kg per shelf.
● lacquered metal.

Item no.	Axle size 1000 mm	Axle size 900 mm	Axle size 750 mm
UNIFLEX	B 8071 0W0 UN	B 8071 0U0 UN	B 8071 0S0 UN
QUADRA	B 8071 0W0 QU	B 8071 0U0 QU	B 8071 0S0 QU
RONDEA	B 8071 0W0 RO	B 8071 0U0 RO	B 8071 0S0 RO



Notes
Complete set of metal shelves with pre-inserted board reinforcement.

Board without	Item no.
Book stop	B 2140 ... (..)
Board with	
Book stop	B 2141 ... (..)

(..) = UN, QU, RO



Slanting hook, Model SSTH
For extractable shelves respectively metal or wooden shelves with projection, prevents the forward tilt of the shelf in the bay; two tilt securings required per shelf, black plastic.

Item no.	1 each
RONDEA	B 8009 000 RO
QUADRA	B 8009 000 QU

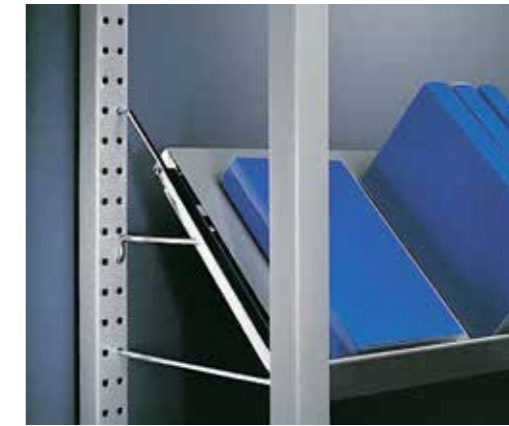

Slanting brace, Model SSTB
For variable slanting of shelves with book stop (edge), for display and front presentation; two each slanting braces required per shelf; round steel, bright galvanized.

Item no.	1 each for metal or wooden shelves
UNIFLEX	B 8010 000 UN
QUADRA	B 8010 000 QU
RONDEA	B 8010 000 RO

Fittings

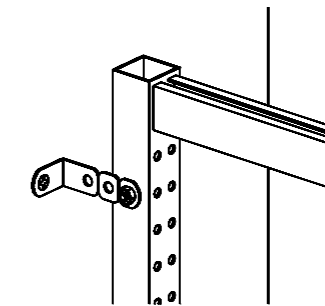

Wall fastening, Model WBEF
For single-sided bays with more than 1100 mm height; bright galvanized metal, incl. fastening kit.
Wall distance 0 – 40 mm.

Item no.	1 each
UNIFLEX	B 8050 000 UN
QUADRA	B 8050 000 QU
RONDEA	B 8050 000 RO

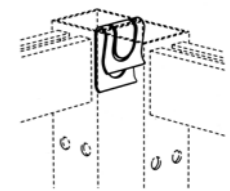

Connection clamp, Model VBKL
For connecting the bearing frames of two adjacent shelving sections, very helpful for extremely high bays or for precise adjustment of the bearing frames, one each is required per shelf connection.
Bright galvanized metal.

Item no.	1 each
UNIFLEX	B 8052 000 UN
QUADRA	B 8052 000 QU



Corner connection angle, Model EVW
For connecting the bearing frames of two shelving sections across the corner, for an even distance between the shelves. Two each are required per shelf connection. Nickel-plated metal, incl. fastening kit.

Item no.	1 each
UNIFLEX	B 8051 000 UN
QUADRA	B 8051 000 QU

Tool kit (no picture)
For mounting of all Schulz shelving systems, consisting of two fork wrenches SW 10 and three Allan keys of 4, 5 and 7 mm

Item no.	Fits all systems
B 8999 000 XX	

Adjusting key for feet (no picture)
For the adjustment of leveling screws.

Item no.	
UNIFLEX	B 8998 000 UN (SW 28)
QUADRA	B 8998 000 QU (SW 28)
RONDEA	B 8998 000 RO (SW 27)



Corner Shelves

Corner shelf for double-sided bays, Model EFD

Wooden shelf for insertion in front side of double-sided bay with a shelf depth of 250 mm, incl. hanging kit, wood veneered/plastic coated. 1 2

Item no.	45° wooden shelf	60° wooden shelf	90° wooden shelf
UNIFLEX	B 2012 M45 UN	B 2012 M60 UN	B 2012 M90 UN
QUADRA	B 2012 M45 QU	B 2012 M60 QU	B 2012 M90 QU
RONDEA	B 2012 M45 RO	B 2012 M60 RO	B 2012 M90 RO



Corner shelf for double-sided bays, Model EFDR

Wooden shelf with rounded front edge, for insertion in front side of double-sided bays with a shelf depth of 250 mm, incl. hanging kit, wood veneered/plastic coated. 1 2

Item no.	45° wooden shelf round	60° wooden shelf round	90° wooden shelf round
UNIFLEX	B 2013 M45 UN	B 2013 M60 UN	B 2013 M90 UN
QUADRA	B 2013 M45 QU	B 2013 M60 QU	B 2013 M90 QU
RONDEA	B 2013 M45 RO	B 2013 M60 RO	B 2013 M90 RO

Corner shelf for single-sided bays, Model EF

Wooden shelf for insertion in front sides of single-sided bay with a shelf depth of 250 mm, incl. hanging kit, 1 2 wood veneered/plastic coated.

90° wooden shelf	Item no.
UNIFLEX	B 2010 M90 UN
QUADRA	B 2010 M90 QU
RONDEA	B 2010 M90 RO

Corner shelf for single-sided bays, Model EFR

Wooden shelf with round front edge, for insertion in front side of single-sided bays with a shelf depth of 250 mm, incl. hanging kit, 1 2 wood veneered/plastic coated.

90° wooden shelf, round	Item no.
UNIFLEX	B 2011 M90 UN
QUADRA	B 2011 M90 QU
RONDEA	B 2011 M90 RO

Trapezoidal shelf for single-sided bays, Model EFI

Wooden shelf for insertion in the front side of single-sided bays with a shelf depth of 250 mm, with rear book stop (edge) which prevents an unintentional slide-through of the media, incl. hanging kit, 1 2 wood veneered/plastic coated.

90° wooden shelf	Item no.
UNIFLEX	B 2020 M00 UN
QUADRA	B 2020 M00 QU
RONDEA	B 2020 M00 RO



Item no.	for Axle size 1000 mm	for Axle size 900 mm	for Axle size 750 mm
UNIFLEX	B 5510 MW0 UN	B 5510 MU0 UN	B 5510 MS0 UN
QUADRA	B 5510 MW0 QU	B 5510 MU0 QU	B 5510 MS0 QU
RONDEA	B 5510 MW0 RO	B 5510 MU0 RO	B 5510 MS0 RO

Hanging desk, rectangular, Model EHT/RE
Reading and computer desk for insertion in bay sections with a shelf depth of 250 mm, numerous modes of use, desk surface 1 2 wood veneered/plastic coated, incl. hanging kit and tilt securing, lacquered metal feet. D 750 mm, H 725 mm



Hanging desk, pentagonal, Model EHT/FE
Reading desk for insertion in bay sections with a shelf depth of 250 mm, also ideal for small and cramped rooms, desk surface from 1 2 wood veneered/plastic coated, incl. hanging kit and tilt stop, lacquered metal feet. H 725 mm

Item no.	for Axle size 1000 mm, D 793 mm	for Axle size 900 mm, D 743 mm	for Axle size 750 mm, D 668 mm
UNIFLEX	B 5513 MW0 UN	B 5513 MU0 UN	B 5513 MS0 UN
QUADRA	B 5513 MW0 QU	B 5513 MU0 QU	B 5513 MS0 QU
RONDEA	B 5513 MW0 RO	B 5513 MU0 RO	B 5513 MS0 RO



Hanging desk, round, Model EHT/RU

Reading and computer desk for insertion in front sides of double-sided bays with a shelf depth of 250 mm, desk surface 1 2 wood veneered/plastic coated, incl. hanging kit, lacquered metal feet. Diameter 1000 mm, D 927 mm, H 725 mm

Item no.	
UNIFLEX	B 5501 M00 UN
QUADRA	B 5501 M00 QU
RONDEA	B 5501 M00 RO



Hanging Tables/Desks

Hanging desk, drop-shaped, Model EHT/TR
Reading and computer desk for insertion in front sides of double-sided bays with a shelf depth of 250 mm when installed as angle 90° combination; offers readers and employees a generous work and display area, desk surface from wood veneered/plastic coated, 1 2 incl. hanging kit, lacquered metal feet. Diameter 1040 mm, H 725 mm

Item no.	
UNIFLEX	B 5500 M00 UN
QUADRA	B 5500 M00 QU
RONDEA	B 5500 M00 RO



Base Cabinets

AV media cabinet, Model MS

Base cabinet with four drawers on telescopic full rails, designed for variable organization through mobile dividers, suitable for different AV media. for individual wall placement or for insertion in shelves with an axle size of 900 mm. Lockable upon request and with rail stop which prevents tilting by simultaneous opening of several drawers.

1 2 3 Wooden body veneered/plastic coated.
W 865 mm, D 600 mm, H 870 mm

Item no.

- B 3495 4U0 (..) with lock, with rail stop (see picture)
B 3495 4U1 (..) without lock, with rail stop
B 3495 4U2 (..) without lock, without rail stop
(for wall mounting)

(..) = UN, QU, RO



Accessories for drawers in AV media cabinet

For variable set-up of drawers with 4 mobile dividers, grooved rubber mat and 2 threading bars from stainless steel, for 200 CDs with standard cover or 1000 CDs with protective sleeve, or 90 DVDs. Metal dividers, silver lacquered.
H 80 mm

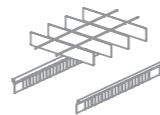

Item no.

- B 3516 0U0 (..) 1 set for 1 drawer
B 3517 000 (..) 1 each additional divider
(..) = UN, QU, RO



Base cabinet with swing door, Model USS

Lockable base cabinet with height adjustable shelf, wood veneered/plastic coated. **1 2 3**
H 870 mm

Item no.

D 400 mm D 600 mm

- | | | |
|----------------------------------|-----------------|-----------------|
| for axle size 1000 mm, W 965 mm, | B 3503 4W0 (..) | B 3504 4W0 (..) |
| Additional shelf | B 3503 0W0 (..) | B 3504 0W0 (..) |
| for axle size 900 mm, W 865 mm, | B 3503 4U0 (..) | B 3504 4U0 (..) |
| Additional shelf | B 3503 0U0 (..) | B 3504 0U0 (..) |

(..) = UN, QU, RO



Base cabinet with sliding doors, Model STS

Lockable base cabinet with height-adjustable shelf, wood veneered/plastic coated. **1 2 3**
H 870 mm

Item no.

D 400 mm D 600 mm

- | | | |
|----------------------------------|-----------------|-----------------|
| for axle size 1000 mm, W 965 mm, | B 3501 4W0 (..) | B 3502 4W0 (..) |
| Additional shelf | B 3501 0W0 (..) | B 3502 0W0 (..) |
| or axle size 900 mm, W 865 mm, | B 3501 4U0 (..) | B 3502 4U0 (..) |
| Additional shelf | B 3501 0U0 (..) | B 3502 0U0 (..) |

(..) = UN, QU, RO

Reading and Pull-out Shelves



Reading and presentation shelf, semicircular, Model ALL

Wooden shelf for insertion in shelving sections with axle size 500 mm and a shelf depth of 250 mm, incl. hanging kit and tilt stops, wood veneered/plastic coated. **1 2**
Axle size 500 mm, D 480 mm

- | | |
|----------------|---------------|
| UNIFLEX | B 2729 MR0 UN |
| QUADRA | B 2729 MR0 QU |
| RONDEA | B 2729 MR0 RO |



Front-side reading and presentation shelf, semicircular, Model ALS

Wooden shelf for insertion in front side of double-sided bay with a shelf depth of 250 mm, easily retrofitted, incl. hanging kit and tilt stops, wood veneered/plastic coated. **1 2**
W 525 mm, D 500 mm

- | | |
|----------------|---------------|
| UNIFLEX | B 2033 M00 UN |
| QUADRA | B 2033 M00 QU |
| RONDEA | B 2033 M00 RO |



Folding board, Model FK

For attachment at front sides of double-sided bays, easy folding for reading, easily retrofitted, lacquered metal. ●
Incl. fastening kit.
W 520 mm, D 300 mm

Item no.

- For attachment on wooden panels
UNIFLEX B 2041 000 UN
QUADRA B 2041 000 QU

- For attachment on shelf bearing frame W 530
UNIFLEX B 2031 0M0 UN
QUADRA B 2031 0M0 QU

- For attachment on shelf bearing frame W 630
UNIFLEX B 2031 0N0 UN
QUADRA B 2031 0N0 QU



Pull-out shelf, Model FAZ

On hidden telescopic full rails, for installation under metal or wooden shelves from axle size 750 mm upwards, width 600 mm, incl. installation kit and tilt stops, lacquered metal. ●



- | | | |
|--|-----------------|-----------------|
| For bearing shelves | wood | metal |
| Pull-out depth 245 mm, front edge flush with bearing shelf | | |
| For bearing shelf D 250 mm | B 2006 M00 (..) | B 2000 M00 (..) |
| For bearing shelf D 300 mm | B 2006 N00 (..) | B 2000 N00 (..) |

Pull-out depth 295 mm, front edge protruding 50 mm over bearing shelf, easier identification as pull-out shelf shelf.

- | | | |
|----------------------------|-----------------|-----------------|
| For bearing shelf D 250 mm | B 2007 M00 (..) | B 2001 M00 (..) |
| For bearing shelf D 300 mm | B 2007 N00 (..) | B 2001 N00 (..) |

(..) = UN, QU, RO



Drawer seat, Model SIK

For use in and insertion in shelving sections, on wheels; with removable, upholstered seat, suitable as storage space. Wood beech multiplex. D 570 mm, H 275 mm

Item no. for Axle size 1000 mm	for Axle size 900 mm	for Axle size 750 mm
UNIFLEX B 8420 0W0 UN	B 8420 0U0 UN	B 8420 0S0 UN
QUADRA B 8420 0W0 QU	B 8420 0U0 QU	B 8420 0S0 QU
RONDEA B 8420 0W0 RO	B 8420 0U0 RO	B 8420 0S0 RO

Presentation grid, straight, Model GISE

For attachment to front of double-sided bays with a shelf depth of 250 mm, as bearing system for presentation elements and an inscription shelf, chromed round steel, incl. fastening material. W 490 mm, H 1750 mm

With four bearing clamps

Item no.
RONDEA B 8200 000 RO

With two connection clips

B 8200 000 (.)

(.) = UN, QU

Presentation grid, angle shaped, Model GISE/W

Similar to Model GISE but with expanded, angle-shaped presentation space. W 490 mm, D 522 mm, H 1750 mm

With four bearing clamps and two connection clips

Item no.
RONDEA B 8201 000 RO

Functional Sides

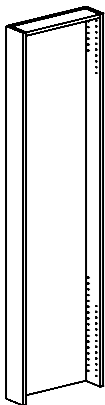

Functional sides, Model FS 1

Either as front side finish or for wall mounting. The functional sides can be individually combined with different equipment for lettering and presentation. They have a signal effect and are ideal for the display and presentation of news or event calendars in folder format. Lettering and inscription can be done directly on the functional side or an additional inscription board. Wood veneered/plastic coated incl. fastening kit. 1 2 3

Functional side	For wall mounting	For UNIFLEX, QUADRA
	B 528 mm	W 528 mm (as side panel)
For bay height	Item no.	Item no.
H 1100 mm	B 8250 GM0 XX	B 8250 GM0 UN,QU
H 1500 mm	B 8250 CM0 XX	B 8250 CM0 UN,QU
H 1750 mm	B 8250 AM0 XX	B 8250 AM0 UN,QU
H 2050 mm	B 8250 DM0 XX	B 8250 DM0 UN,QU
H 2250 mm	B 8250 EM0 XX	B 8250 EM0 UN,QU

For shelf depth 300 mm = N (B 640/628 mm) the M in the item no. will be replaced by an N.

Inscription shelf, Model BT 1

For a colour emphasis and for information. Wood veneered/plastic coated incl. fastening kit. W 489 mm, H 368 mm. Schulz Lettering Service upon request

Item no. B 8260 0M0 XX **Fits all systems**

For shelf depth 300 mm = N (B 589 mm) the M of the item no. will be replaced by an N.



Folder rack, Model FL 1

For an organized presentation of folders. With acrylic glass front, H 120 mm and three removable dividers. Shelf width 115 mm, Wood veneered/plastic coated. W 489 mm, H 140 mm

Item no. B 8262 0M0 XX **Fits all systems**

For shelf depth 300 mm = N (B 589 mm) the M in the item no. will be replaced by an N.

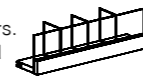

Display shelf, Model PT 1

For the presentation of media and for colour emphasis. Lacquered metal. W 489 mm, H 255 mm

Item no. B 8261 0M0 XX **Fits all systems**

For shelf depth 300 mm = N (B 589 mm) the M of the item no. will be replaced by an N.

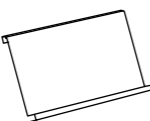

Inscription board, Model BSGI (see left picture)

Easy fixing on presentation grid, as sign post and orientation aid, beech multiplex. W 400 mm, H 284 mm

Item no. B 8202 000 (.)

(.) = UN, QU, RO



Hanging metal display, Model ZFVH
 For insertion in presentation grid, side panels from perforated sheet metal with round holes RG 5/25, square holes QG 10/62.5 and slot holes 4/40, as well as two holding rods Model B 1 also for direct insertion in shelf front sides, W 90 mm, H 200 mm, insert size up to 50 mm, chromed metal.

Item no.
Fits all systems B 8211 000 XX



Book presenter, Model BAH 5
 For placing or hanging in presentation grid, side panels from perforated sheet metal with round holes RG 5/25, square holes QG 10/62.5 and slot holes 4/40, as well as two holding rods Model B 1 also for direct insertion in shelf front sides, for German DIN A4 formats such as paperbacks, video cassettes etc., chromed metal.

Item no.
Fits all systems B 8210 000 XX



Holding/bearing rod, Model B 1

As holder for front-side presentation elements, for insertion into grid systems of the bearing frame, easily height adjustable, bright galvanized round steel.

Item no.
 1 each for shelf depth 250 mm
UNIFLEX B 8001 M00 UN
QUADRA B 8001 M00 QU
RONDEA B 8001 M00 RO

For shelf depth 300 mm = N
 the M in the item no. will be replaced by an N.

Book Presentation

Slanted shelf 60°, Model SAB 60

For the presentation of books, magazines etc., For hanging in presentation grid and front sides of double-sided shelves.
 ● Lacquered metal, incl. hanging kit.
 W 469 mm, D 290 mm

Item no.
UNIFLEX B 8222 0M0 UN
QUADRA B 8222 0M0 QU
RONDEA B 8222 0M0 RO
PRESENT.GRID B 8222 0M0 GI



Front-side shelves, Model STFB
 For hanging into presentation grids and front sides of double-sided bays, for books (see pic.1), with additional CD shelf rack B 8500 003 XX (see page 27) also suitable for ● 42 CDs (see pic.2), lacquered metal, incl. hanging kit.
 W 469 mm, D 250 mm, H 120 mm

Item no.
UNIFLEX B 8221 0M0 UN
QUADRA B 8221 0M0 QU
RONDEA B 8221 0M0 RO
PRESENT.GRID B 8221 0M0 GI



Comic and map box, Model CTR

For hanging in shelving sections with a shelves depth of 250 mm, allows user to easily flip through media with simultaneous front presentation, variable set-up through mobile dividers, also suitable for videos and DVDs, grooved rubber mat, hanging kit and tilt stops.
 D 376 mm, H 200 mm

● 1 2 box and dividers from lacquered metal, incl. wooden sides, grooved rubber mat, hanging kit and tilt stops.
 D 376 mm, H 200 mm

Item no.

for axle size 1000 mm, incl. 3 dividers for ca. 136 comics
 B 8602 MW0 (. .)
 for axle size 1000 mm, incl. 5 dividers for ca. 162 maps
 B 8602 MW1 (. .)
 for axle size 900 mm, incl. 2 dividers for ca. 102 comics
 B 8602 MU0 (. .)
 for axle size 900 mm, incl. 4 dividers for ca. 135 maps
 B 8602 MU1 (. .)
 (. .) = UN, QU, RO



Item no.
 1 each additional divider for Comic and map box
 B 8603 000 (. .)
 (. .) = UN, QU, RO

Book Presentation



Book manger, Model BT 2
 With slanted shelf for front or book spine presentation of different media, for hanging in presentation grids and front sides of double-sided bays, insertion width/depth up to 450/200 mm, incl. hanging kit, beech multiplex.
 W 480 mm, D 260 mm, H 205 mm

Item no.
UNIFLEX B 8216 2W0 UN
QUADRA B 8216 2W0 QU
RONDEA B 8216 2W0 RO
PRESENT.GRID B 8216 2W0 GI



Paperback box, Model TBT 2
 For hanging in presentation grids and front sides of double-sided bays, insertion width/depth up to 450/150 mm, incl. hanging kit, beech multiplex.
 W 480 mm, D 183 mm, H 150 mm

Item no.
UNIFLEX B 8215 2W0 UN
QUADRA B 8215 2W0 QU
RONDEA B 8215 2W0 RO
PRESENT.GRID B 8215 2W0 GI



CD and paperback holder, Model CDH
 For hanging in perforated sheet metal panels with round holes RG 5/25 and slot holes 4/40, bright galvanized metal, variable width, insert size up to 25 mm, H 60 mm. Picture shows on pair

Item no.
Fits all systems B 8209 000 XX on pair



Broadside box (Querbox ©) for magazines in shelves, Model ZQB

For storing of magazines in bays with 250 mm shelf depth. When opened, the display flap for the current issue can be pushed in for easy handling. An additional, transparent antireflex foil allows presentation of a front page for easy identification of the chosen issue. Magazines are stored broadside in this box with the advantage that the magazine spines can be seen from the front and that the magazines are stored with more care, compared to boxes with standing magazines, and they can easily be taken out. Stacking height 140 mm, max. magazine size W 230 mm, H 315 mm. Box and flap made of lacquered metal, max. 3 each on shelf boards with axle size 1000 mm. W 320 mm, D 260 mm, H 320 mm

Item no.
Fits all systems B 8311 000 XX

Other models:

Magazine box, Model ZBV, (no picture)

Upright storage of magazines on shelf depth 250 mm. With adjustable back. Stacking height 140 mm, max. magazine size W 230 mm, H 310 mm. Box and flap made of lacquered metal, max. 4 each on shelf with axle size 1000 mm. W 238 mm, D 260 mm, H 320 mm

Item no.
Fits all systems B 8310 000 XX

Magazine box, Model ZBL, (no picture)

Broadside storage of magazines on board depth 300 mm and above. Stacking height 140 mm, max. magazine size W 230 mm, H 310 mm. Box and flap made of lacquered metal, max. 4 each on shelf with axle size 1000 mm. W 238 mm, D 340 mm, H 320 mm

Item no.
Fits all systems 0 3016 010

Magazine Presentation

Magazine presenter, Model ZSA

A slanted back and an additional side stop are a very organized way of presenting single magazine stacks in shelves with a shelf depth of more than 250 mm. The binder or folder will be placed flush with the front edge which has a double reinforced edging. For use with metal shelves, we have included an additional slip stop to the front. Lacquered metal, back height 300 mm, depth of storage area 80 mm.

Item no.
Fits all systems B 8025 A40 XX German DIN A4, width 220 mm, max. 4 each
 On shelves axle size 1000 mm
Fits all systems B 8025 A30 XX German DIN A3, width 440 mm, max. 2 each
 On shelves axle size 1000 mm



Sectioned shelf, Model MB

For insertion in shelving section with axle size 1000 mm and a shelf depth of 300 mm, for horizontal display and storage of magazines in German DIN A4 format (see picture 1), randomly expandable with slanted shelves (see picture 2), lacquered metal, incl. dividers for four rows of magazines. D 300 mm, H 150 mm

for axle size 1000 mm
Item no.
UNIFLEX B 2060 NWO UN
QUADRA B 2060 NWO QU
RONDEA B 2060 NWO RO



Slanted shelf board, Model ZF 3

For insertion shelving section with axle size 1000 mm and a shelf depth of 300 mm, for presenting the recent issue of magazines brochures etc., lacquered metal, incl. hanging kit. D 300 mm

Item no.
UNIFLEX B 2611 NWO UN
QUADRA B 2611 NWO QU
RONDEA B 2611 NWO RO



Connectable magazine collector, Model ZSSA

Slanted magazine sections for storing current brochures, pamphlets, forms, etc. randomly connectable side by side through plug-in connections, max. 9 each on axle size 1000 mm, max. 8 each on axle size 900 mm, max. 6 each on axle size 750 mm, lacquered metal. Single element: W 95 mm, D 240 mm, H 300 mm

Item no.
Fits all systems B 8026 000 XX



U-support, Model UST

Multiple uses, p.e. for loose-leaf collections, music books etc., lacquered metal. W 145 mm, D 220 mm, H 250 mm

Item no.
Fits all systems B 8027 000 XX

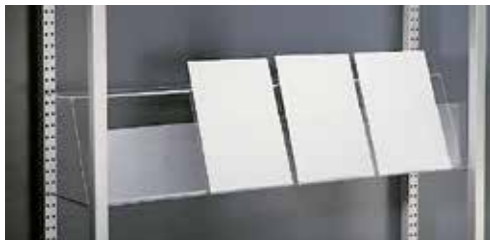

Brochure shelf, Model BRF

For insertion in shelving section with a shelf depth of 250 mm, for the presentation of pamphlets, magazines, brochures etc., highly transparent acrylic glass with upward front edge H 160 mm, incl. hanging kit. D 232 mm, H 220 mm

Item no.	For axle size 1000 mm	For axle size 900 mm	For axle size 750 mm
UNIFLEX	B 2050 0W0 UN	B 2050 0U0 UN	B 2050 0S0 UN
QUADRA	B 2050 0W0 QU	B 2050 0U0 QU	B 2050 0S0 QU
RONDEA	B 2050 0W0 RO	B 2050 0U0 RO	B 2050 0S0 RO



Plastic insert, Model ZF/EIN

For placement on slanted shelves with book stop and a shelf depth of 300 mm, has a 60 mm high edge and is ideal for storing newspaper or magazine stacks as well as thick books, allows the display of front pages as orientation aid, highly transparent acrylic glass. D 296 mm, H 60 mm

Item no.	For axle size 1000 mm	For axle size 900 mm	For axle size 750 mm
Fits all systems	B 8321 NW0 XX	B 8321 NU0 XX	B 8321 NS0 XX



Transparent foil, Model ZFF

For placement on slanted shelves with book stop and a shelf depth of 300 mm, allows the display of front pages as orientation aid, highly transparent acrylic glass. Axle size 1000 mm, D 295 mm (shorter sizes by cutting)

Item no.	For axle size 1000 mm
Fits all systems	B 8322 0W0 XX

Newspaper and Magazine Presentation

Continuous magazine flap, Model DZK

You can display three current titles, the previous versions are stored behind – broadside on the shelf. Broadside stacking has the great advantage that all inscriptions and prints on the spine can still be seen from the front. An effective lever mechanism supports the comfortable handling and keeps the lifted flap open. Easily retrofitted for single- and double-sided bays with axle size 1000 mm and a shelf depth of 250 mm. In order to prevent a slip-through to the back, we recommend using shelves with backs. Shelves H 2250 mm can be equipped with max. 6 flaps high. Stacking height for German DIN A4: 160 mm.

- Flap and sides from lacquered metal, W 961 mm, H 340 mm, without shelf

Item no.	For axle size 1000 mm
UNIFLEX	B 8315 MW0 UN
QUADRA	B 8315 MW0 QU



Universal hanging cage, Model UEKB

Use as book stand (see pic.1), display shelf (see pic.2) or newspaper manger (see pic.3), for hanging in presentation grid and front sides of up to 420 mm, incl. hanging kit, chromed round steel. W 435 mm, D 120/40 mm, H 273 mm

Item no.	For axle size 1000 mm
UNIFLEX	B 8212 000 UN
QUADRA	B 8212 000 QU
RONDEA	B 8212 000 RO
PRESENT.GRID	B 8212 000 GI



Newspaper holder, Model ZHK

For newspapers, brochures etc., for hanging in presentation grids and front sides of double-sided bays, incl. hanging kit, highly transparent acrylic glass. W 350 mm, H 260 mm

Item no.	For axle size 1000 mm
UNIFLEX	B 8219 000 UN
QUADRA	B 8219 000 QU
RONDEA	B 8219 000 RO
PRESENT.GRID	B 8219 000 GI

Slanted display 60° shelf, Model SAB 60

For displaying books, magazines etc., for hanging in presentation grids and front sides of double-sided shelves, lacquered metal, incl. hanging kit. W 469 mm, T 290 mm

Item no.	For axle size 1000 mm
UNIFLEX	B 8222 0M0 UN
QUADRA	B 8222 0M0 QU
RONDEA	B 8222 0M0 RO
PRESENT.GRID	B 8222 0M0 GI



Plastic magazine collector, Model ZESA

Helpful for the storage of brochures, pamphlets, loose-leaf collections etc., with front-side edge for guiding along the shelf board and for attaching inscriptions, light grey plastic. W 80 mm, D 230 mm, H 325 mm

Item no.	For axle size 1000 mm
Fits all systems	B 8313 000 XX 1 each





LED presentation board

Are you proud of your new acquisitions, or would you like to present different types of media on one specific topic? Our LED presentation board offers you the appropriate frame. It has a perforated metal front which can be equipped and individually combined with all kinds of presentation accessories.

State-of-the-art LED technology will definitely attract the visitors' attention, with a minimum of electricity consumption and extreme durability.

This LED presentation board is also well suitable to brighten up some less frequented dark corners, niches and hallways.

Comes with 29 LEDs, ready for operation, incl. plug and cable for 250V socket.

Perforated sheet metal, lacquered; with put-on sign for lettering upon request.

LED presentation board without accessories

W 870 mm, D 60 mm, H 1650 mm

Item no. B 7706 AU0 XX

LED presentation board without accessories

W 870 mm, D 60 mm, H 1950 mm

Item no. B 7706 DU0 XX

Sign

Lacquered metal, W 300 mm, D 40 mm, H 150 mm

Schulz Lettering Service upon request

Item no. B 8102 000 XX

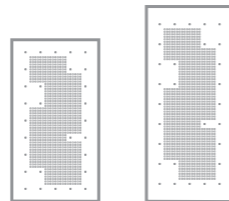

Presenting Digital Media



Sign

Lacquered metal, W 300 mm, D 40 mm, H 150 mm

Schulz Lettering Service upon request

Item no. B 8102 000 XX

CD Display wall

Is ideal for presenting small media. This display wall will show your CDs and CD-ROMs at their best and give the user an optimum access to your "Top 10" or other groups and subjects like no other piece of furniture. The CD display is available either for individual mounting on wooden bases or in different widths already installed on a wall board.

If desired, a sign with inscription will attract additional attention.

CD display: lacquered metal,

Wooden wall board veneered/plastic coated. 1 2 3

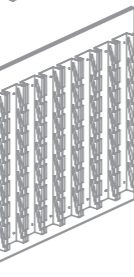
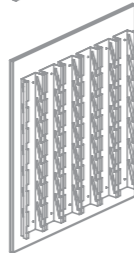
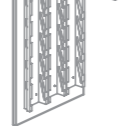
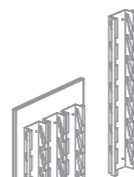

CD Display

For individual mounting on wooden bases such as side panels, cabinet sides etc., incl. fastening material, for 7 CDs, W 148 mm, D 50 mm, H 900 mm

Item no. B 7711 000 XX

CD display wall

For wall mounting incl. fastening material and CD display for a total of 21 CDs (see drawing). W 550 mm, D 89 mm, H 1100 mm

Item no. B 7710 003 XX

CD display wall

For wall mounting incl. fastening material and 6 CD displays for a total of 42 CDs. W 1000 mm, D 89 mm, H 1100 mm

Item no. B 7710 006 XX

CD display wall

For wall mounting incl. fastening material and 9 CD display for a total of 63 CDs. W 1450 mm, D 89 mm, H 1100 mm

Item no. B 7710 009 XX

	Item no.	Item no.
For shelf depth 250	Axle size 1000 Incl. 5 dividers for approx. 180 CDs	Axle size 900 incl. 4 dividers for approx. 150 CDs
	UNIFLEX QUADRA RONDEA	B 8600 MU0 UN B 8600 MU0 QU B 8600 MU0 RO
	B 8600 MW0 UN B 8600 MW0 QU B 8600 MW0 RO	B 8600 MU0 UN B 8600 MU0 QU B 8600 MU0 RO

For shelf depth 300 mm
the M in the item no. will be replaced by an N.

Fits all systems B 8601 000 (.) 1 each additional divider
(.) = UN, QU, RO



AV media tray, Model MEHT

For hanging in bays with a shelf depth of 250 and 300 mm. allows user to easily flip through media with simultaneous front presentation. Variable management through mobile dividers, suitable for different types of AV media, tray and dividers from lacquered metal, wooden sides veneered/plastic coated, incl. grooved rubber mat, threading bars, hanging kits and tilt stops.

D 376 mm, H 100 mm, tray height 80 mm

1 2

Multimedia browser as top shelf (see picture), Model MMW

For an organized and space-saving storage of CDs, CD-ROMs, DVDs, videos or cassettes in shelves.

Allows user to easily flip through media with simultaneous front presentation. Variable management by mobile dividers. browser made of lacquered metal,

for fixing on wooden and metal shelves. Depth 250 mm without book stop. Browser height 100 mm, Incl. grooved rubber mat.

	Item no.	Item no.
For shelf depth 250	Axle size 1000 Incl. 5 dividers for approx. 120 CDs/DVDs with standard cover	Axle size 900 incl. 4 dividers for approx. 100 CDs/DVDs with standard cover
	B 8620 MW1 XX	B 8620 MU1 XX
Fits all systems	B 8621 M00 XX 1 each additional divider	

Multimedia browser for insertion (no picture), Model MMWE

Same description as above, but with side consoles for direct insertion in bays with a shelf depth of 250 mm.

	Item no.	Item no.
For shelf depth 250	Axle size 1000 Incl. 5 dividers for approx. 120 CDs/DVDs with standard cover	Axle size 900 incl. 4 dividers for approx. 100 CDs/DVDs with standard cover
	B 8620 MW2 (.)	B 8620 MU2 (.)
Fits all systems	B 8621 M00 XX 1 each additional divider	

(.) = UN, QU,

RO



Pull-out multimedia browser (see picture), Model MMWA

Several browsers can be placed on top of each other by a telescopic full rail in order to save room in a bay with board shelf 250 mm. An additional handle makes the user aware of this pull-out function.

Same description as above, but with side consoles, pull-outs, handle and tilt stops.

	Item no.	Item no.
For shelf depth 250	Axle size 1000 Incl. 5 dividers for approx. 120 CDs/DVDs with standard cover	Axle size 900 incl. 4 dividers for approx. 100 CDs/DVDs with standard cover
	B 8620 MW0 (.)	B 8620 MU0 (.)
Fits all system	B 8621 M00 XX 1 each additional divider	
B 8623 000 XX	1 each DVD-rest for clipping onto the rear perforated row for heightening the back panel. If requested, one is required per DVD row.	



Multimedia stair, connectable, 2 steps



Multimedia stair, connectable, 3 steps

Multimedia stair, connectable, Model MMT

Flexible solution for room-saving storage of CDs, CD-ROMs or DVDs in shelves with shelf depth 250 mm. The stair can be placed single or double – and also triple on top of each other in front of the shelf. A slight slanting gives you an ideal view and you can easily reach the media. This system is a perfect supplement for the pull-out multimedia browser or the AV media tray, if placed single or double on top of these. Browser from lacquered metal, incl. hanging kit ●
D 110 mm, height of front edge 50 mm

For front presentation	Axle size 1000 mm for approx. 60 CDs	Axle size 900 mm for approx. 60 CDs
Item no.	B 8510 MW0 (. .) 1 each	B 8510 MU0 (. .) 1 each
Grooved rubber mat for multimedia stair		
Item no.	B 8511 MW0 (. .)	B 8511 MU0 (. .)
	(. .) = UN, QU, RO	

Multimedia browser, Model MMK

CDs, CD-ROMs, DVDs and also videos can be stored by either presenting their title or side by side presenting their back. Both arrangements can be ideally seen and handled because the browser has a slanted position. For large stocks of media, this multimedia browser is an ideal supplement for the pull-out multimedia browser or our AV media tray which will be inserted in the shelves. ● Browser from lacquered metal, incl. hanging kit. D 165 mm, edge height 140 mm

For shelf depth D 250 mm	Axle size 1000 mm	Axle size 900 mm
For front presentation	For approx. 90 CDs	For approx. 90 CDs
For back presentation	For approx. 95 CDs	For approx. 85 CDs
Item no.	B 2080 MW0 (. .)	B 2080 MU0 (. .)
	(. .) = UN, QU, RO	



Presenting Digital Media

CD and paperback holder, Model CDH

For insertion in perforated end panels with round holes RG 5/25 and slot holes 4/40, bright galvanized steel wire, variable width. Insertion strength up to 25 mm, H 60 mm

Fits all systems	Item no. B 8209 000 XX
-------------------------	----------------------------------



Presentation tray, Model TRK 2

With 2 dividers for approx. 60 CDs, for insertion in presentation grids and also front sides of double-sided bays, beech multiplex, incl. five dividers, grooved rubber mat and hanging kit. W 480 mm, D 285 mm, H 136 mm

Item no.	B 8213 2W0 UN
UNIFLEX	B 8213 2W0 QU
QUADRA	B 8213 2W0 RO
RONDEA	B 8213 2W0 GI
PRESENT.GRID	

Shelf for front side, Model STFB

For hanging in presentation grids and front sides of double-sided bays, for additional CD shelf tops B 8500 003 XX or B 8501 003 XX (see left) lacquered metal, incl. hanging kit. ● W 469 mm, D 250 mm, H 120 mm
without CD shelf top

Item no.	B 8221 0M0 UN
UNIFLEX	B 8221 0M0 QU
QUADRA	B 8221 0M0 RO
RONDEA	B 8221 0M0 GI
PRESENT.GRID	

CD shelf board top, Model CDA

Can be easily fixed on metal or wooden shelves with a depth of 250 mm, also suitable for shelves with a book stop edge, allows the user to easily flip through the CDs with simultaneous front presentation, available in designs with two or three rows, and for CDs in standard or protective cover, random placement side by side, chromed round steel. W 464/311 mm, D 262 mm, H 40 mm

The following is needed to completely equip a shelf:

For axle size 1000 mm:	2 each, three-rowed
For axle size 900 mm:	1 each, three-rowed, 1 each, two-rowed
For axle size 750 mm:	2 each, two-rowed
For axle size 500 mm:	1 each, three-rowed

Fits all systems

Item no.	B 8500 003 XX
1 each, three-rowed, for 42 CDs with standard cover, 10.5 mm thick	
Item no.	B 8500 002 XX
1 each, two-rowed, for 28 CDs with standard cover, 10.5 mm thick	
Item no.	B 8501 003 XX
1 each, three-rowed, for 30 CDs with protective cover, 18.5 mm thick	
Item no.	B 8501 002 XX
1 each, two-rowed, for 20 CDs with protective cover, 18.5 mm thick	



Thematic Browser, Model TW 1

For storing theme-related AV media such as CDs, CD-ROMs, DVDs next to the relevant books. Random placement on shelves or tables/desks. Browser from lacquered metal, with anti-slipping feet. ● W 150 mm, D 220 mm, H 120 mm

Item no.	B 8505 000 XX	for ca. 20 CDs/DVDs
Fits all systems	B 8506 000 XX	grooved rubber mat for thematic browser





Lights for Shelves

Horizontal light, Model HL 1

Will be plugged onto the bearing frames of single and double-sided shelves. Also possible for covering two axle sizes without a middle lamp arm. For a hidden cable conduct to the floor, 1 per shelf row for single-sided bays and 2 UNIFLEX light bearing frames for double-sided bays have to be planned (with cable outlet K1). For a central control.

Protrusion approx. 300 mm to front edge of lamp, lacquered metal, incl. acrylic cover, ● T8 lamp and electronic ballast. Cannot be combined with doors.

1 basic horizontal light with 2 lamp arms,
2 front-side covers, cable with mains plug 1.5 m black

Item no.	Item no.	Item no.
Axle size 1000 mm B 8730 1WG UN	Axle size 900 mm B 8730 1UG UN	Axle size 750 mm B 8730 1SG UN

1 add-on horizontal light with 1 lamp arm

Item no.	Item no.	Item no.
Axle size 1000 mm B 8730 1WA UN	Axle size 900 mm B 8730 1UA UN	Axle size 750 mm B 8730 1SA UN

1 basic horizontal light covering two axle sizes continuously



Halogen shelf light, Model HRL 2

For completely illuminating a shelf and also for accent lights. For single- or double-sided bays: will be plugged on special UNIFLEX light bearing frames (with cable outlet K1) for a hidden cable conduct to the floor.

Lamps incl. halogen reflector lamp for voltage 230V/50W and feed line to the base. For central control.

Protrusion approx. 300 mm to the front edge of lamp, Lacquered metal. Cannot be combined with doors. ●

Item no.
UNIFLEX B 8700 000 UN 1 Halogen shelf lamp for UNIFLEX light bearing frames

Mains connection and interlinking of lights is made by electric mains and connection cables in the shelf base.

Connection cable with Schuko plug incl. distribution coupling for cable conduct in the shelf base, is required 1x per shelf row.

Item no.
UNIFLEX B 8701 000 UN 1 meter, black
UNIFLEX B 8701 003 UN 3 meter, black

Connection cable for single- and double-sided bays, Incl. distribution coupling for cable conduct in the shelf base.

Item no.
UNIFLEX B 8702 000 UN standard length for max. Axle size 1000 mm, required 1x per add-on shelf, black

Vertical light, Model T 5

For installation on the standard bearing frames of single- and double-sided bays.

Lights incl. 2 fluorescent tubes 21 W, length 912 mm, electronic ballast and diffuser for perforated plate.

We offer outer and middle shelf lights for an optimum light distribution.

All lights can be controlled centrally or individually.

- Protrusion approx. 65 mm to the front edge of the lamp, lacquered metal. Cannot be combined with doors or with protruding accessories such as broadside boxes, pull-out multimedia tubs etc.

	Item no.	Item no.	Item no.
	1 outer light left type	1 middle light	1 outer light right type
For bay height 2050 mm	B 8722 D0L UN	B 8722 D0M UN	B 8722 D0R UN
For bay height 2250 mm	B 8722 E0L UN	B 8722 E0M UN	B 8722 E0R UN

Other bay heights upon request.

Mains connection and interlinking of lights are made by electric mains with triple plugs in the shelf base.

2 lines are required for double-sided bays, for single-sided starter bays and single- or double-sided add-on bays only one line is required.

Item no.
B 8723 000 XX 1 mains connection and interlinking line

Our shelving system UNIFLEX offers numerous other possibilities for making lights effective where it is required.

Continuous light assemblies with round or square profiles can be installed at different lamp holders and shelf connectors.





Signage

Labelling sign, Model L 3

For marking of sections, simply clip on metal or wooden shelves, incl. exchangeable moisture-proof labelling strips white, labelling sign transparent plastic, antireflex H50 mm. Schulz Labelling Service upon request.



Item no.	for axle size 1000 mm	for axle size 900 mm	for axle size 750 mm	for axle size 500 mm
UNIFLEX	B 8038 0W0 UN	B 8038 0U0 UN	B 8038 0S0 UN	B 8038 0R0 UN

Blank labelling strips white, moisture-proof, for axle size 1000 mm, (shorter sizes by cutting)

Item no. B 8039 0W0 UN

Front Side Signage



Inscription triangle, Model DRE

Can be read in row direction, will be hung in the bearing frame as top shelf finish when used as front side labelling, for bay heights above 2200 mm to guarantee the required headroom, incl. exchangeable, moisture-proof labelling strip white, holder lacquered metal, labelling strip transparent plastic, antireflex H 50 mm. Schulz Labelling Service upon request

Item no.

For single-sided bays with shelf depth 250 mm
UNIFLEX B 8087 ME0 UN

For single-sided bays with shelf depth 300 mm
UNIFLEX B 8087 NE0 UN

Item no.

For double-sided bays with shelf depth 250 mm
UNIFLEX B 8087 MD0 UN

For double-sided bays with shelf depth 300 mm
UNIFLEX B 8087 ND0 UN

Blank labelling strips white, moisture-proof for shelf depth 250 mm

UNIFLEX B 8088 OM0 UN

Blank labelling strips white, moisture-proof, for shelf board 300 mm

UNIFLEX B 8088 ON0 UN



Labelling sign, Model K 3

Front side labelling for insertion in the bearing frame as top shelf finish, incl. Exchangeable moisture-proof Labelling strip white, labelling sign Transparent plastic, antireflex. Two labelling signs are required for Double-sided shelves. H 50 mm. Schulz Labelling Service upon request

Item no.

1 each for shelf depth 250 mm
UNIFLEX B 8085 M00 UN

1 each for shelf depth 300 mm
UNIFLEX B 8085 N00 UN

Item no.

Blank labelling strips white, moisture-proof, for shelf depth 250 mm

UNIFLEX B 8086 M00 UN

Blank labelling strips white, moisture-proof, for shelf depth 300 mm

UNIFLEX B 8086 N00 UN

Labelling Flags

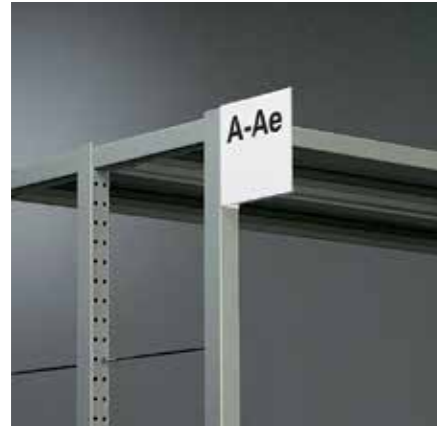

Labelling flag, Model FA 3
For insertion in the outer posts of bearing frames, lacquered metal. W 120 mm, H 120 mm
Schulz Labeling Service upon request.

Item no.

With transparent plastic cover, incl. labelling cardboard white
UNIFLEX B 8095 00K UN
QUADRA B 8095 00K QU

Without transparent plastic cover with self-stick letters
UNIFLEX B 8095 000 UN
QUADRA B 8095 000 QU

For screwing onto end panels, with transparent plastic cover, incl. labelling cardboard white.
UNIFLEX B 8096 00K UN
QUADRA B 8096 00K QU

For screwing onto end panels, without transparent plastic cover, with self-stick letters
UNIFLEX B 8096 000 UN
QUADRA B 8096 000 QU

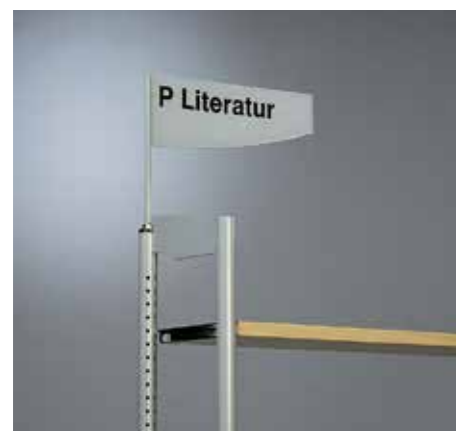

Metal labelling flag, Model BSFS
For insertion in shelf posts, randomly turn; flag and holding rod from lacquered metal, height 300 mm, flag W 400 mm, minimum height 80 mm.
Schulz Labeling Service upon request

Item no.

UNIFLEX B 8099 000 UN
QUADRA B 8099 000 QU
RONDEA B 8099 000 RO

Labelling flag, Model FA 5
For hanging in the outer posts of bearing frames, for German DIN A5 format, lacquered metal. W 210 mm, H 148 mm.
Schulz Labeling Service upon request.

Item no.

With transparent plastic cover, incl. labelling cardboard white.
UNIFLEX B 8082 A5K UN
QUADRA B 8082 A5K QU

Without transparent plastic cover, with self-stick letters.
UNIFLEX B 8082 A50 UN
QUADRA B 8082 A50 QU

For screwing onto end panels, with transparent plastic cover, incl. labelling cardboard white.
UNIFLEX B 8083 A5K UN
QUADRA B 8083 A5K QU

For screwing onto end panels, without transparent plastic cover, with self-stick letters
UNIFLEX B 8083 A50 UN
QUADRA B 8083 A50 QU

Holding rod, Model BSHT
For insertion in shelf posts, For fixing of up to three metal labelling flags, Model BSFM, bright galvanized metal. H 350 mm.

Item no.

UNIFLEX B 8098 000 UN
QUADRA B 8098 000 QU
RONDEA B 8098 000 RO

Metal labelling flag, Model BSFM

For use with holding rod, randomly turn or fix. Lacquered metal, W 400 mm, H 90 mm
SchulzLabelingService upon request

Item no.

UNIFLEX B 8097 000 UN
QUADRA B 8097 000 QU
RONDEA B 8097 000 RO

Labelling Boards

Turn-board holder, Model WTH
For installation at front sides of shelves, for clear and open presentation of information, for max. 21 turn-boards in German DIN A4 format. Black plastic, without turn-boards.

Item no.

For installation on bearing frames of double-sided bays
UNIFLEX B 8090 000 UN
QUADRA B 8090 000 QU

For installation onto end panels or for wall-mounting
UNIFLEX B 8091 000 UN
QUADRA B 8091 000 QU

5 turn-boards for German DIN A4 format with double-sided labelling field, transparent plastic, incl. turning rod.
UNIFLEX B 8092 000 UN
QUADRA B 8092 000 QU



Labelling Boards



Labelling board with acrylic glass cover, Model BTP

For hanging on front sides of single- or double-sided bays, for German DIN A4 format, with 6 mm acrylic glass cover, back is lacquered metal white, incl. fastening material. W 212 mm, H 301 mm
Schulz Labeling Service upon request.

Item no.

1 each for single- or double-sided bays with shelf depth 250 mm (see picture 1)
UNIFLEX B 8080 M40 UN
QUADRA B 8080 M40 QU
RONDEA B 8080 M40 RO

1 each for single- or double-sided bays with shelf depth 300 mm
UNIFLEX B 8080 N40 UN
QUADRA B 8080 N40 QU
RONDEA B 8080 N40 RO

1 each for centre fixing in double-sided bays (see picture 2)
UNIFLEX B 8080 044 UN
QUADRA B 8080 044 QU
RONDEA B 8080 044 RO

1 each for end panels from perforated plates, with round holes RG 5/25 (see picture 3)
UNIFLEX B 8080 043 UN
QUADRA B 8080 043 QU
RONDEA B 8080 043

RO

1 each for end panels from perforated plates, with square holes QG 10/62,5
UNIFLEX B 8080 048 UN
QUADRA B 8080 048 QU
RONDEA B 8080 048 RO

1 each for wooden end panels (see picture 4)
UNIFLEX B 8080 042 UN
QUADRA B 8080 042 QU
RONDEA B 8080 042 RO



Shelf Labelling



Tagboard, Model AKS 2

For clip onto metal or wooden shelves with below groove, shifting, incl. exchangeable labeling white strip transparent plastic, antireflex. W 210/105 mm, H 21 mm

Schulz Labeling Service upon request

Item no.
Tagboard B 210 mm
Fits all systems B 8040 000 XX

Blank labelling white strip, sheets of 13 strips, W 209 mm
Fits all systems B 8041 000 XX

Tagboard B 105 mm
Fits all systems B 8040 200 XX

Blank labelling white strip, sheets of 13 strips, W 104 mm
Fits all systems B 8041 200 XX

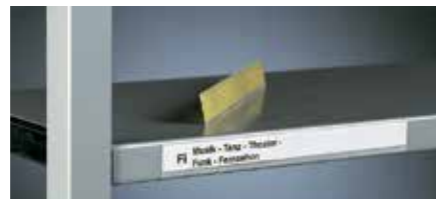

Lettering tag, Model KA/S

For retrofitted installation on metal or wooden shelves with smooth edges, self-sticking, incl. exchangeable labelling white strip transparent plastic. W 147/200 mm, H 20 mm

Schulz Labeling Service upon request

Item no.
Labelling sign B 200 mm
Fits all systems B 8044 200 XX

Labelling sign B 147 mm
Fits all systems B 8044 201 XX

Blank labelling white strip, sheets of 13 strips, W 209 mm (shorter sizes by cutting)
Fits all systems B 8041 000 XX



Magnet sign, Model KA/M

For metal boards with smooth edge, Magnetic, incl. exchangeable labelling white strip with transparent plastic cover. W 210 mm, H 20 mm

Schulz Labeling Service upon request

Fits all systems **Item no.** B 8045 000 XX

Blank labelling white strip, sheets of 13 strips, W 209 mm (shorter sizes by cutting)
Fits all systems B 8041 000 XX



Labelling cube, Model BEWÜ

Universal use for all shelving systems, for attaching labelling between books, incl. inscription field with transparent cover and exchangeable labelling white cardboard, transparent plastic. W 120/200 mm, T 200, H 200 mm

Schulz Labeling Service upon request

Item no.
Labelling cube B 120 mm
Fits all systems B 8060 000 XX

Labelling cube B 200 mm
Fits all systems B 8060 200 XX



Book substitute, Model STV

As substitute for when books are taken out etc., universal use for all shelving systems, with welded transparent pocket; white, blue, green or red plastic. W 153 mm, H 74 mm

Schulz Labeling Service upon request

Fits all systems **Item no.** B 8061 000 XX



Labelling bearer, Model BET

Universal use by simply placing on shelf, incl. exchangeable labelling white strip; white lacquered metal. W 150 mm, D 150 mm, H 26 mm

Schulz Labeling Service upon request

Fits all systems **Item no.** B 8019 000 XX

Blank labelling white strip, sheets of 13 strips, W 209 mm (shorter sizes by cutting)
Fits all systems B 8041 000 XX

Pictograms
Self-sticking icons for orientation and guiding systems, W 130 mm x H 130 mm. More icons and sizes upon request.

Fits all systems **Item no.** B 8554 . . . XX

Item no. B 8554 001 XX	B 8554 002 XX	B 8554 003 XX	B 8554 004 XX	B 8554 029 XX	B 8554 030 XX
Item no. B 8554 005 XX	B 8554 006 XX	B 8554 017 XX	B 8554 018 XX	B 8554 031 XX	B 8554 032 XX
Item no. B 8554 007 XX	B 8554 008 XX	B 8554 019 XX	B 8554 020 XX	B 8554 033 XX	B 8554 044 XX
Item no. B 8554 009 XX	B 8554 010 XX	B 8554 021 XX	B 8554 022 XX	B 8554 043 XX	B 8554 034 XX
Item no. B 8554 011 XX	B 8554 012 XX	B 8554 023 XX	B 8554 024 XX	B 8554 035 XX	B 8554 036 XX
Item no. B 8554 013 XX	B 8554 014 XX	B 8554 025 XX	B 8554 026 XX	B 8554 037 XX	B 8554 038 XX
Item no. B 8554 015 XX	B 8554 016 XX	B 8554 027 XX	B 8554 028 XX	B 8554 039 XX	B 8554 040 XX

Colour Range

Colours carry a large expressiveness and are effective at first sight. Particularly in architecture does colouring play an important role. We are offering you the possibility of individually combining different surfaces with an extensive colour programme in order to design your furniture.

Library Furniture 2012/14

System Counter DIALOG

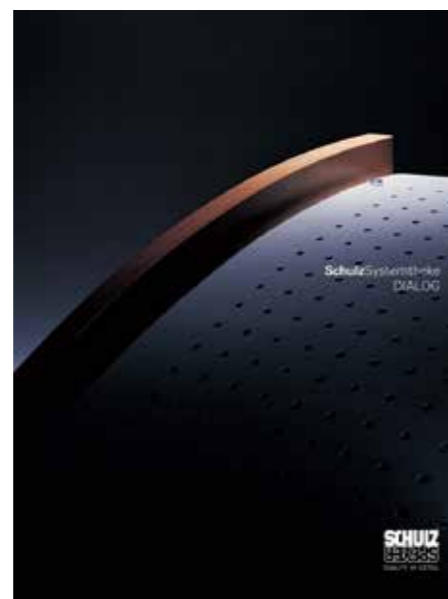

Price group

A

Price group

B

Price group

C

We furnish libraries!

The centre of all our activities is you, our customer. Your satisfaction is our most important capital. In order to find your individual solution we already support you during the planning phase. If you are looking for competent consulting, We are there for you, also on the spot. Tell our specialists about your needs and use our know-how from many a thousand realised furnishing projects.



Our name stands for innovative product design and development. Furniture for today and tomorrow. And being an all-round equipper we offer a complete delivery programme for all kinds of libraries.

Besides the library furniture presented in this catalogue, you will find more product groups like shelving systems and shelving accessories as well as counter systems in separate catalogues or under www.schulzspeyer.de.

We are looking forward to your inquiries.

Photo: M. J. Smets

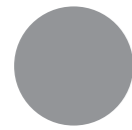

Colours for metal coatings

The coloration of the metal parts is made by a highly abrasion-proof and environmental-friendly baking powder-coating. With reservation for colour deviations to original RAL register. Antibacterial equipping of surfaces upon request.

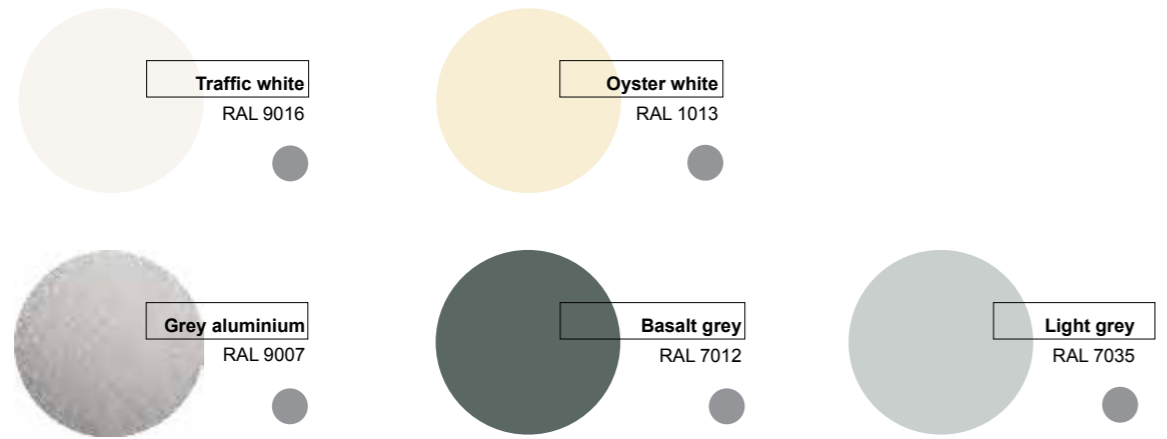

Surfaces from solid wood veneer and plastic

Wooden surfaces are either directly plastic-coated or covered with an HPL laminated plastic, depending on their application. Differences in colour underline the characteristics of solid wood surfaces and cannot be avoided. Solid wood changes its colours under the influence of light. Table and work surfaces with solid wood veneer have only limited abrasion resistance. We recommend our highly resistant plastic decors for these types of surfaces. We use environmental-friendly lacquers for our solid wood surfaces.

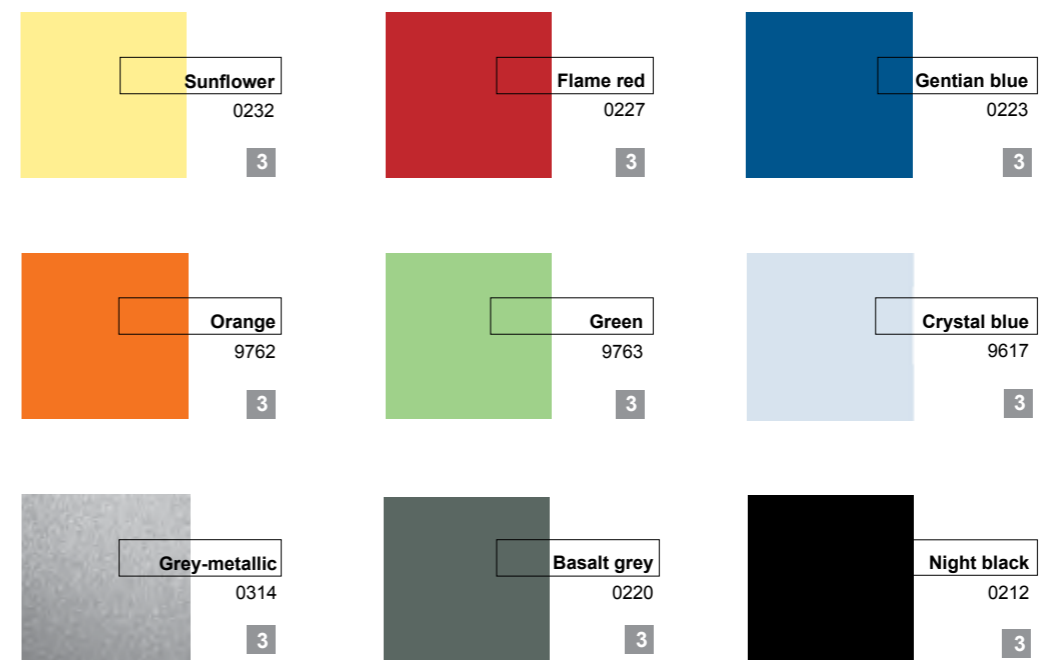
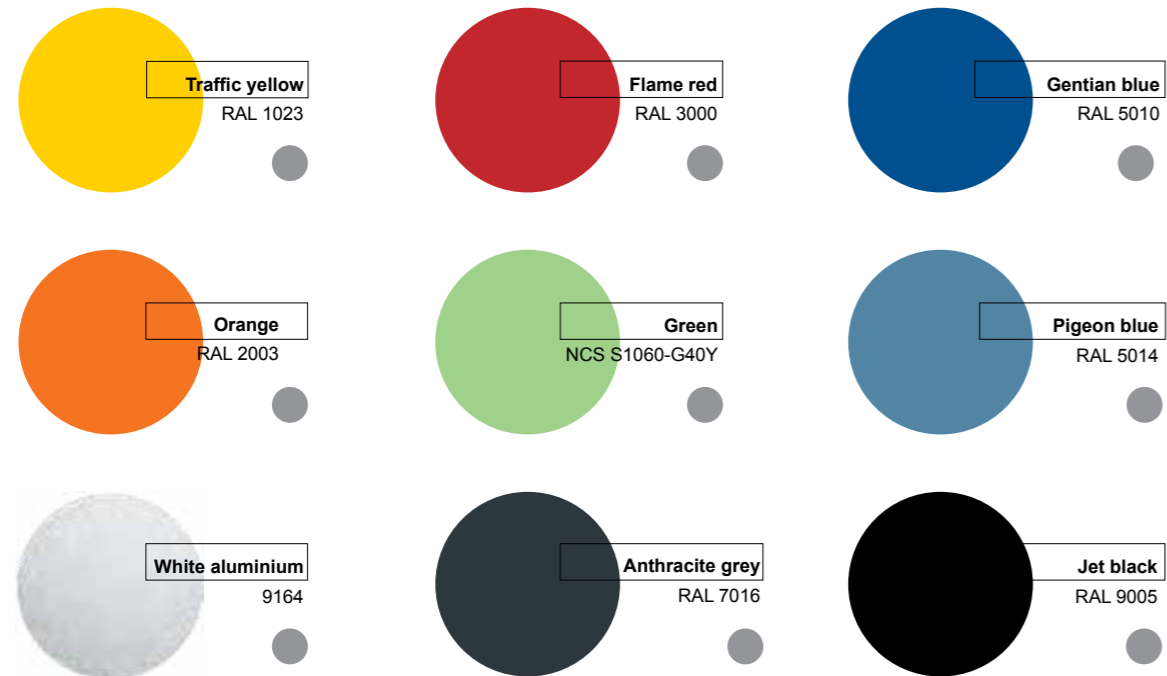
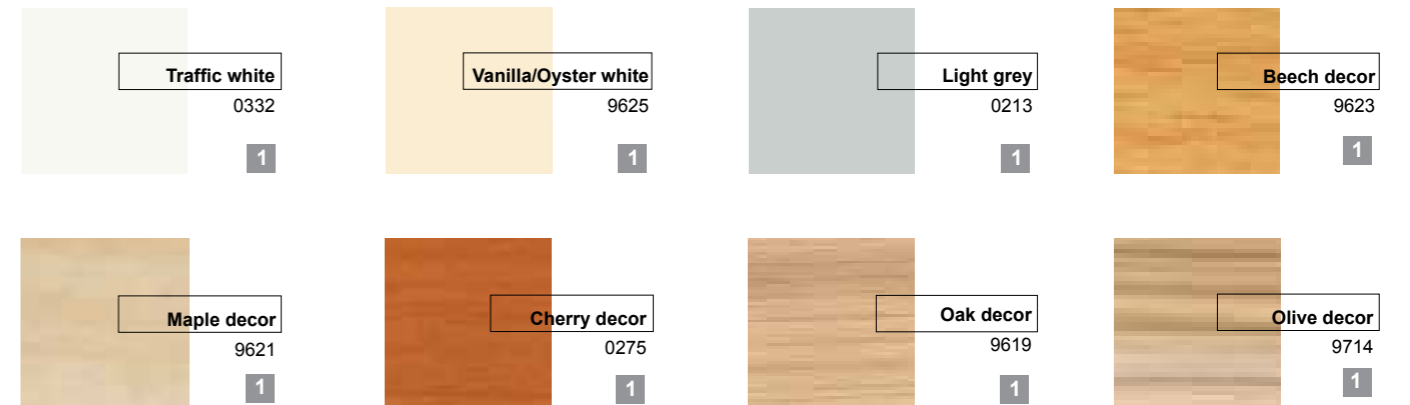

RAL 5003 Sapphire blue
RAL 9011 Graphite black
DB 702 Iron mica light
DB 703 Iron mica dark
Other colours, fine structures and glimmer lacquerings upon request.

(1) We do not recommend fine-structured surfaces for shelf boards as the books will slip easily!



Other surfaces and veneers upon request.